



# Temperature calibrators TP17 / TPM series



Table of contents	page
0 About this operating manual.....	4
1 Device description .....	5
1.1 Delivery, unpacking and accessories .....	6
1.2 Intended use.....	7
1.3 Warranty.....	7
1.4 Exclusion of liability .....	8
2 Safety Instructions .....	8
2.1 Safety instructions for the application of calibration liquids .....	10
3 Construction and function .....	11
3.1 Construction.....	11
3.2 Functions.....	12
3.3 Data interface (S versions).....	12
4 Commissioning and operation .....	14
4.1 Operating conditions .....	14
4.2 Electrical connection .....	15
4.3 Preparation of the calibrator .....	16
4.3.1 Dry block calibrator .....	17
4.3.2 Micro bath calibrator .....	18
4.4 Switching on, cool down and switching off.....	22
4.5 Operating modes.....	23
5 Operation .....	24
5.1 Control elements of the controller (controller type K32SK) .....	24
5.2 Calibration (calibration mode) .....	25
5.2.1 Display of reference and set temperature .....	25
5.2.2 Display of temperature control .....	25
5.2.3 Display of fan/ cooling control.....	26
5.2.4 Display of heating / cooling capacity and operating duration.....	26
5.2.5 ConF menu.....	26
5.3 Set a temporary set temperature (set point mode).....	27
5.4 Main menu.....	28
5.4.1 Automatic control .....	30
5.4.2 Manual control.....	31
5.4.3 Set point memory (S version) .....	32
5.4.4 Gradient control / temperature profile (S version) .....	33

6	Testing process / Calibration .....	39
6.1	Testing temperature sensors .....	39
6.2	Testing process .....	39
7	Problems .....	41
7.1	Return shipment to the manufacturer.....	42
8	Maintenance, cleaning and transport .....	43
8.1	Maintenance .....	43
8.1.1	Recalibration.....	44
8.2	Cleaning.....	45
8.3	Transport.....	46
9	Decommissioning and disposal .....	47
10	Technical data.....	48
10.1	Shared characteristics.....	48
10.2	Characteristics TP 17... series .....	49
10.3	Characteristics TP 17...S .....	50
10.4	Characteristics TP M...S series .....	51
10.5	Heating and cooling periods .....	52
10.5.1	TP 17165, TP 17166, TP 17200 (dry block) .....	52
10.5.2	TP 17450, TP 17650 (dry block).....	53
10.5.3	TP M165S .....	53
10.5.4	TP M255S .....	54
11	Guideline DAkkS-DKD-R 5-4 • Appendix B.....	55

**Copyright notice:**

The reproduction, distribution and utilization of this operating manual as well as the communication of its contents to others without express authorization is prohibited. Offenders will be held liable for the payment of damages. All rights reserved in the event of the grant of a patent, utility model or design.

## 0 About this operating manual

- The operating manual is aimed at specialists and semi-skilled personnel.
- Before each step, read through the relevant advice carefully and keep to the specified order.
- Thoroughly read and understand the information in the section "Safety Instructions".
- For calibrators with a cooling function, the term "Cooling" is also used for temperatures below room temperature, in the meaning of "Heating".

If you have any problems or questions, please contact your supplier or contact us directly at:



Dr. Siebert & Kühn GmbH & Co. KG  
 Struthweg 7-9 • D - 34260 Kaufungen  
 ☎ 05605-803 0 • 📠 05605-803 54  
 info@sika.net • www.sika.net

### Hazard signs and other symbols used:



CAUTION! Electric current!

This sign indicates dangers which could arise from handling of electric current.



WARNING! / CAUTION! Risk of injury!

This sign indicates dangers that cause personal injuries that can lead to health defects or cause considerable damage to property.



CAUTION! High temperature!

This sign indicates dangers resulting from high temperature that can lead to health defects or considerable damage to property.



CAUTION! Material damage!

This sign indicates actions which could lead to possible damage to material or environmental damage.



ADHERE TO OPERATING MANUAL!



NOTICE!

This symbol indicates important notices, tips or information.



NO DOMESTIC WASTE!

The device must not be disposed of together with domestic waste.

- ⚠ Pay attention to and comply with information that is marked with this symbol.

- ☐ Check the specified points or notices.
- Reference to another section, document or source.

- 👉 Follow the specified instructions and steps. Adhere to the given order.

- Item.

# 1 Device description

The calibrators of the TP17 / TPM series serve for testing and calibrating different temperature measuring instruments and temperature sensors, as well as for measurement of temperatures.



The portable instruments are of compact and robust construction and thus allow use directly on-site or in a laboratory.

The TP17 / TPM series is used for service purposes and for different industrial and laboratory tasks.

Thus, for example, thermometers, temperature switches/thermostats, resistance thermometers and thermo-elements can be directly connected and checked.

**Versions\*:**

The TP17 / TPM series includes the following calibrator / micro bath types:

Metal block calibrators:			Micro baths:				
TP 17165	(c+h)		TP 17450	(h)	TP M165S	(c+h)	
TP 17165 S	(c+h)		TP 17450S	(h)			
TP 17166	(c+h)		TP 17650	(h)		TP M255S	(h)
TP 17166 S	(c+h)		TP 17650S	(h)			
TP 17200	(c+h)						
TP 17200S	(c+h)						

c+h: cooling and heating    h: heating

Metal block calibrators

Micro bath calibrators



TP 17165...  
TP 17166...  
TP 17200...



TP 17450...  
TP 17650...



TP M165...



TP M255...

**Type plate:**

You find the type plate on the rear of the device.

It includes the type designation, the serial number and the key electric specifications.



\* Customised versions available on request.

## 1.1 Delivery, unpacking and accessories

All units have been carefully checked for their operational reliability before shipment.

- Immediately after receipt, please check the outer packaging for damages or any signs of improper handling.
- Report any possible damages to the forwarder and your responsible sales representative. In such a case, state a description of the defect, the type and the serial number of the device.  
Report any in-transit damage immediately. Damage reported at a later date shall not be recognized.

### Unpacking:

-  Carefully unpack the unit to prevent any damage.
-  Check the completeness of the delivery based on the delivery note.



Save the packaging!

Temperature calibrators are delivered in special protective packaging.



-  Save the packaging for returning the instrument safely to the manufacturer for recalibration or repair.

### Scope of delivery and accessories (included):

<p><b>Metal block calibrator:</b></p> <ul style="list-style-type: none"> <li><input type="checkbox"/> Metal block calibrator according to order data.</li> <li><input type="checkbox"/> Mains cable.</li> <li><input type="checkbox"/> Sleeve exchange tools.</li> <li><input type="checkbox"/> Test certificate.</li> <li><input type="checkbox"/> Operating manual.</li> <li><input type="checkbox"/> Protective packaging and transport protection.</li> </ul>	<p><b>Micro bath:</b></p> <ul style="list-style-type: none"> <li><input type="checkbox"/> Micro bath calibrator according to order data.</li> <li><input type="checkbox"/> Mains cable.</li> <li><input type="checkbox"/> Seal cover.</li> <li><input type="checkbox"/> Work cover with five silicone plugs.</li> <li><input type="checkbox"/> Sensor cage.</li> <li><input type="checkbox"/> Magnetic stirrer.</li> <li><input type="checkbox"/> Magnetic lifter.</li> <li><input type="checkbox"/> Drain pump.</li> <li><input type="checkbox"/> Test certificate.</li> <li><input type="checkbox"/> Operating manual.</li> <li><input type="checkbox"/> Protective packaging and transport protection.</li> </ul>
---	--



### IMPORTANT!

-  Use the type plate to check if the delivered unit corresponds to your order.
-  In particular, for devices with electrical components, check to see if the correct power supply voltage is specified.

## 1.2 Intended use

The calibrators of the TP17 / TPM series may only be used for testing and calibration of suitable temperature measuring instruments, temperature sensors and for measuring temperatures.

The calibrators may not be used for warming up or heating other parts or gases.

The calibrators have been designed for indoor use only.

The micro baths may only be used with suitable media. Permitted liquids are silicone oils, mineral oils and water (→ § 2.1 "Safety instructions for the application of calibration liquids").

Hazardous media (flammable or explosive liquids or gases) may not be used.

The operational safety of the device supplied is only guaranteed by intended use. The specified limits (→ § 10 "Technical data") may under no circumstances be exceeded.

### CAUTION! Risk of burns!

The calibrator can become very hot when in operation. Touching hot parts can result in serious injuries.



- ↳ Never touch the metal block, the tank, the adapter sleeve or the test specimen at temperatures above 35 °C or below 10 °C.
- ↳ Allow the calibrator to cool before you remove the test specimen, clean the tank, change the adapter sleeve or the calibration insert or switch off the machine.

### CAUTION! Material damage!

The opening in the metal block of the calibrator is only intended to be used with adapter sleeves or calibration inserts.



Using heat transfer media (oil, thermal paste or other media) can lead to incorrect measurements and damage to the calibrator.

- ↳ Never fill the metal block opening with a heat transfer medium.
- ↳ Only micro baths are suitable for use with heat transfer medium.

It is your responsibility to select the instrument which is suitable for your specific application, to connect it correctly, to carry out tests and to maintain all the components.

## 1.3 Warranty

The calibrator is under guarantee for 12 months as from the date of delivery for construction errors or material defects. The guarantee is limited to repair or replacing the calibrator.

SIKA also provides an extra 5-year guarantee for calibrators which are calibrated and inspected annually by the SIKA-DAkKS laboratory.

Opening the calibrator, unauthorised repairs or incorrect use or installation of the calibrator automatically result in the warranty being rendered null and void.



## 1.4 Exclusion of liability

We accept no liability for any damage or malfunctions resulting from incorrect installation, in-appropriate use of the device or failure to follow the instructions in this operating manual.

## 2 Safety Instructions



Before you install the TP17 / TPM, read through this operating manual carefully. If the instructions contained within it are not followed, in particular the safety guidelines, this could result in danger for people, the environment, and the device and the system it is connected to.

The TP17 / TPM corresponds to the state-of-the-art technology. This concerns the accuracy, the operating mode and the safe operation of the device.

In order to guarantee that the device operates safely, the operator must act competently and be conscious of safety issues.

SIKA provides support for the use of its products either personally or via relevant literature. The customer verifies that our product is fit for purpose based on our technical information. The customer performs customer- and application-specific tests to ensure that the product is suitable for the intended use. With this verification all hazards and risks are transferred to our customers; our warranty is not valid.

### Qualified personnel:

⚠ The personnel who are charged for the installation, operation and maintenance of the TP17 / TPM must hold a relevant qualification. This can be based on training or relevant tuition.

The personnel must be aware of this operating manual and have access to it at all times.

### General safety instructions:

⚠ In all work, the existing national regulations for accident prevention and safety in the workplace must be complied with. Any internal regulations of the operator must also be complied with, even if these are not mentioned in this manual.

⚠ Ensure that the complete operating instructions are always available in excellent condition at the calibrator installation site.

⚠ Degree of protection according to EN 60529:

Ensure that the ambient conditions at the site of use do not exceed the requirements for the stated protection rating (→ § 10 "Technical data").

⚠ Structural safety in accordance with EN 61010-1:

The calibrator must be installed in such a way that the requirements for structural safety are met.

⚠ Only use the TP17 / TPM if it is in perfect condition. Damaged or faulty devices must be checked without delay and, if necessary, replaced.

If problems cannot be cleared, immediately shut down the calibrator and ensure that it cannot be started up accidentally.



- ⚠ Never leave the calibrator unattended when it is in operation or in the cooling phase.
- ⚠ Do not remove or obliterate type plates or other markings on the device, as otherwise the warranty is rendered null and void.

**Special safety instructions:**

- ⚠ Thermal fuse!  
The calibrator is equipped with a temperature fuse that works independently. If there is an over-temperature in the inside of the housing, the power supply to the heating system is cut off. The calibrator cannot then be started any more.
  - ↪ After it has cooled, send the calibrator for inspection to SIKA.
- ⚠ Risk of injury from hazardous gases!  
When liquids are heated, the evaporation can result in dangerous gases being formed.
- ⚠ The calibrator may not be used in an explosion-endangered atmosphere (ignitable or explosive atmosphere).
  - ↪ Remove all the easily flammable media from the vicinity of the calibrator.
  - ↪ Ensure that the calibrator cannot come in contact with easily flammable or explosive media.
- ⚠ Operate the calibrator only in the temperature range permissible for the test sample.
- ⚠ Ensure that the test sample is securely fixed in the calibrator.
  - ↪ Use only suitable adapter sleeves or calibration inserts.  
When doing so, also ensure that the structural safety of the calibrator is retained.

**IMPORTANT NOTICE!**

The transport cover is equipped with a safety valve, which is activated once the pressure reaches ~1.5 bar. This can result in hot steam being released.

- ↪ Always unscrew the transport cover before putting the micro bath into service, in order to avoid excessive pressure.
- ↪ Wait until the micro bath has cooled down before screwing on the transport cover.

Further warnings that are specifically relevant to individual operating procedures or activities can be found at the beginning of the relevant sections of this operating manual.

## 2.1 Safety instructions for the application of calibration liquids

- ⚠ Before using calibration liquids, read the entire safety data sheet attentively. Pay particular attention to the information on the physical and chemical properties.
- ⚠ Only use calibration liquids that are suitable for the required temperature range and which are not flammable.
- ⚠ Always wear safety goggles for the eyes when handling calibration liquids.

We recommend the following calibration liquids for the various temperature ranges:

Calibration liquid	Calibration range		Flashpoint
<b>Distilled water</b>	2...95 °C		none
<b>Silicone oil from XIAMETER®:</b>			
PMX-200 SILICONE FLUID 5 CS	-40 °C	123 °C	133 °C
PMX-200 SILICONE FLUID 10 CS	-35 °C	155 °C	165 °C
PMX-200 SILICONE FLUID 20 CS	7 °C	220 °C	230 °C
PMX-200 SILICONE FLUID 50 CS	50 °C	270 °C	280 °C

### Water:

- ⚠ Only use distilled water, otherwise excessive limescale and soiling will build up in the calibrator tank.

### Silicone oil:

- ⚠ Use only the silicone oil recommended here.
- ⚠ Always read the safety data sheet supplied with the silicone oil before using it.
- ⚠ Always ensure adequate ventilation when working with silicone oil, since hazardous substances can be released.
- ⚠ Prevent silicone oil from coming into contact with your eyes.
- ⚠ Since silicone oil is hygroscopic, always use the transport cover to close the calibration bath after use.

**IMPORTANT NOTICE! Release of pollutants!**



During the heating of the silicone oil at temperatures > 150°C in the presence of air, small quantities of formaldehyde may be released.

Adequate ventilation is required, so that the permissible MAK value of 0.5 ppm in the 8-hour average in the workplace during normal operation is not exceeded.

### Mineral oil:

- ⚠ SIKA supplies the calibrators only with silicone oil.
- ⚠ Using mineral oil is possible, but must be done on your own responsibility. The danger and the risk must be borne by the customer and our warranty will be rendered null and void.
- ⚠ Please follow the safety data sheet of the mineral oil used.
- ⚠ The safety instructions for silicone oil apply analogously for mineral oils as well. The same also applies to the corresponding sections for silicone oil in this operating manual.

### 3 Construction and function

#### 3.1 Construction

The calibrator consists of a robust, black-and-red painted steel housing ② and has a carrying handle at the top ①.

The front part of the housing holds the electronics of the TP17 / TPM, the controller ③ with display and control elements, the thumb wheel for the magnetic stirrer ⑧.

On the front side are the main switch with fuse and mains plug connection ⑤ as well as the service and data interface ④.

The grille ⑨ for the exhaust air is located, in the TPM calibrators, in both the side walls of the housing. In the TP17 calibrators, the grille ⑨ is located in the upper plate of the housing in the range of the opening of the metal block.

The rear part of the housing holds a heat-insulated calibration block with heating or cooling elements and an integrated sensor for the reference temperature. In the case of the dry block and multifunction calibrator, this is a metal block ⑥ and in the micro bath calibrator, it is a tank ⑦.

In the base, there are grilles for cooling the calibrator. The in-built fans control the inlet air of the housing ⑩ and of the calibration block ⑪.

An overview of the most important components of the TP17 / TPM:

- ① Carrying handle.
- ② Steel housing.
- ③ Controller with display and control elements.
- ④ Service and data interface.
- ⑤ Main switch with fuse and mains plug socket.
- ⑥ Metal block (Dry block).
- ⑦ Tank (Micro bath) with transport cover.
- ⑨ Calibrator ventilation: Exhaust through upper housing grilles.
- ⑩ Calibrator ventilation: Exhaust through lateral housing grilles.
- ⑪ Thumb wheel magnetic stirrer.

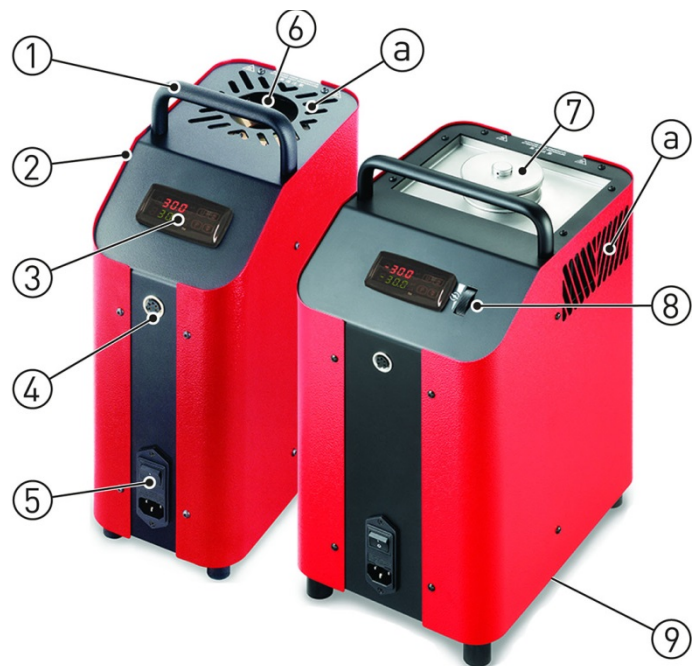

Calibrator, bottom view:

- ⑪ Calibrator ventilation
  - ⑩ Inlet air for housing cooling.
  - ⑪ Inlet air for tank / metal block cooling.



### 3.2 Functions

The calibrators can be used with dry block or micro bath function.

The function is determined by the calibrator type and the used measuring insert.

Type \ Function	Dry block	Micro bath
Measuring insert:	Adapter sleeve	Calibration liquid
TP 17200...	✓	-/-
TP 17165...	✓	-/-
TP 17166...	✓	-/-
TP 17450...	✓	-/-
TP 17650...	✓	-/-
TP M165...	-/-	✓
TP M255...	-/-	✓

#### Method of working:

Adapter sleeves or calibration inserts that are suitable for the temperature sensors or temperature measuring instruments to be tested are inserted in the calibrator (→ § 4.3 "Preparation of the calibrator").

They give the test specimen a secure fit and ensure optimum heat transfer.

Once all the preparations have been carried out, the calibrator can be switched on (→ § 4.4).

The calibrator heats or cools the metal block or calibration liquid to the set temperature. As soon as this temperature has been reached and is stable, the calibration of the test specimen can be carried out.

Then, the next test point is approached or the testing procedure is ended.

### 3.3 Data interface (S versions)

The S version is equipped with a serial communication interface RS485. It is possible to connect a PC, a level converter or a network via this interface.

The utilized software protocol is a MODBUS-RTU protocol, which is used in numerous market-available monitoring programs. A separate document for the protocol can be supplied on request.

The transfer rate (baud rate) is factory set to 9600 baud. Other transfer rates are available on request.

The 5-pole socket is provided with two connections, A and B, which have to be connected to the respective sockets of the PC, the level converter or the network.

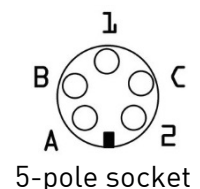

To enable connection to a PC, the RS 485 signals have to be externally converted into RS 232 or USB signals. Appropriate converters including drivers are optionally available. The PC records all the operating data and enables the programming of all the calibrator's configuration parameters.

The minimum requirements for operation with a USB converter are:

- IBM compatible PC,
- installed operating system Windows 7, Windows 8 or Windows 10,
- a free USB port (USB 1.1 or USB 2.0).

A network configuration allows the connection of up to 32 calibrators / micro baths to the same network.

Certain factory settings have to be carried out to enable configuration of a network. In this case, please contact your supplier or SIKA directly.

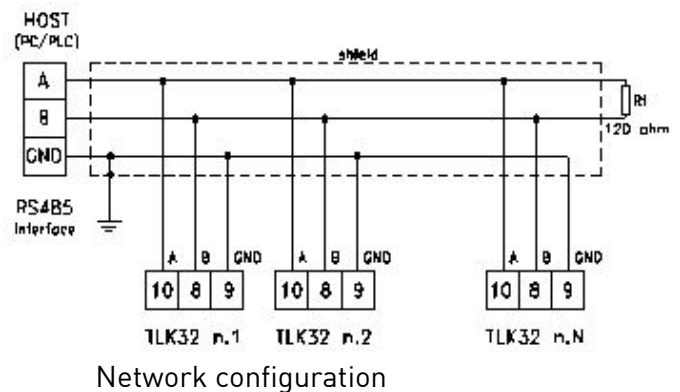

**PLEASE NOTE:**

If you access the programming via the keypad while communication via a serial interface is running, the message **"buSy"** appears on the display.

## 4 Commissioning and operation

### CAUTION! Risk of injury or material damage!



The calibrator can become very hot during operation. If the machine is operated without supervision, third-party persons in the vicinity could get injured. Moreover, flammable material could get into the machine and cause significant damage to property.

⚠ Never leave the calibrator unattended when it is in operation or in the cooling phase.

For safe operation of the calibrators of the TP17 / TPM series, a proper commissioning procedure is necessary.

Commissioning includes the installation, the electrical connections, the preparation for the calibration as well as correct switching on and off of the device.

Further, a visual inspection for damage is required before use.

The required steps are described in the following sections.



### IMPORTANT!

Please also follow the instructions for intended use (→ § 1.2), the safety instructions (→ § 2) and the information on the ambient conditions (→ p. 48).

### 4.1 Operating conditions

Select a safe installation site for commissioning the machine.

#### Installation site and operating position:

- Only suitable for indoor use, do not use outdoors.
- Operate only in the vertical position on an even surface. The surface must be stable, clean, and dry.  
If the operation positions do not conform to the above, the structural safety and the specified properties of the calibrator are not guaranteed.
- At higher testing temperatures, please use a sufficiently big, fire-resistant supporting surface.
- Sufficient clearance around the machine  
On the front side > 1 m, behind and to the sides > 0.5 m. Head clearance and sufficient clear space above the machine.
- Sufficient ventilation must be ensured.
- Do not operate in the vicinity of flammable materials.
- Do not install in a cupboard or other similar object.
- The ventilation openings must not be blocked or covered.
- The machine must be so installed that it can be switched off at any time.

#### IMPORTANT! "KILL" switch!



The plug of the mains connecting cable serves as a "KILL" switch.

⚠ Ensure that the plug is always easily accessible and easy to reach.

⚠ In an emergency, pull the plug, so that the machine is isolated from the mains.

## 4.2 Electrical connection

The electrical connections are made with the accompanying mains connecting cable.

### **DANGER! Risk of death due to electric current!**



The TP17 / TPM is operated at mains voltages up to 240 V<sub>AC</sub>. Contact with the mains voltage can result in serious or fatal injuries.

↪ Switch off the TP17 / TPM and remove the mains connecting cable before you start any work on live parts.

Check the following points before you connect the calibrator:

- Operate the machine only with the approved supply voltage (→ § 10). Ensure that the mains voltage is the same as that specified on the type plate.
- Please follow the local regulations of the energy supplier.
- Connect the calibrator only to a properly installed and earthed 3-pole outlet for Schuko plugs.
- Do not use any extension cables or adapter plugs.

### **IMPORTANT! Mains connecting cable!**



The mains connecting cable may only be replaced by an equivalent cable.

↪ Use only original cables from SIKA or approved cables of the same type with the correct design as replacements (→ § 10.1...10.4 "Electrical characteristics").

### **Connect TP17 / TPM:**

- ↪ Connect the mains connecting cable with the connector plug of the TP17 / TPM.
- ↪ Insert the plug of the mains connecting cable in a suitable outlet.



### 4.3 Preparation of the calibrator

The preparations for the test task must be carried out with the calibrator switched off and cooled to ambient temperature.

#### CAUTION! Risk of burns!

The calibrator can become very hot when in operation. Touching hot parts can result in serious burn injuries.



- ⚠ Never touch the metal block, the tank, the adapter sleeve or the test specimen at temperatures above 35 °C or below 10 °C.
- ⚠ Allow the calibrator to cool before you remove the test specimen, clean the tank, change the adapter sleeve or the calibration insert or switch off the machine.

#### Measuring inserts:

The function of the calibrator is determined by the measuring insert. The required measuring insert is inserted in the opening of the metal block or the tank.

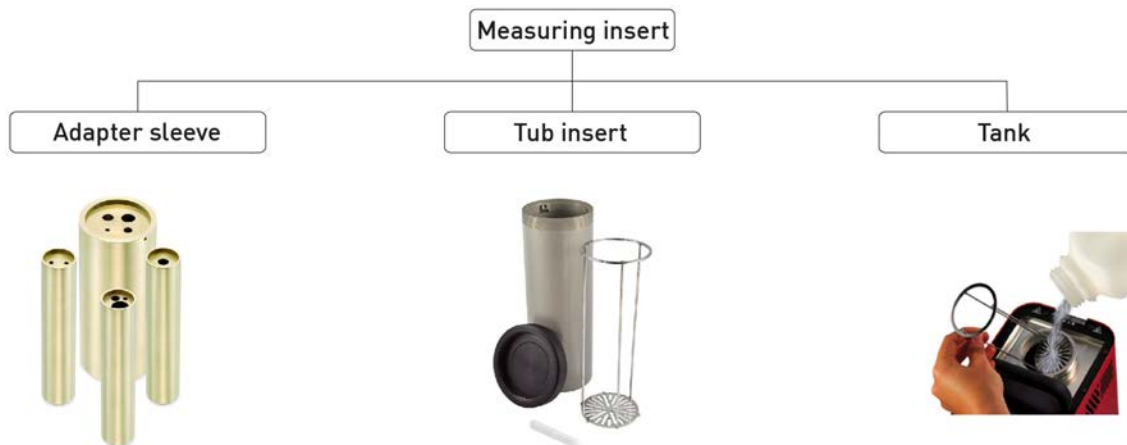

Which measuring insert you can use in which calibrator type is shown in the table in § 3.2.

### 4.3.1 Dry block calibrator

Type	TP 17200	TP 17165	TP 17166	TP 17450	TP 17650
<b>Dry block</b>	✓	✓	✓	✓	✓

Adapter sleeves with single or multiple holes are used for the calibration of straight temperature sensors.

To achieve the specified accuracy of the calibrators (→ § 10.1...10.4) the temperature sensor (test specimen) and the adapter sleeve must be matched to one another:

- ↪ The borehole of the adapter sleeve may be a maximum of 0.5 mm larger than the diameter of the test specimen.
- ↪ The measurement element of the test specimen must be located in the homogeneous temperature zone of the adapter sleeve.
- ↪ Please also note the "Details of the DKD technical committee "Temperature and Humidity" for the operation of temperature block calibrators" (→ § 11).

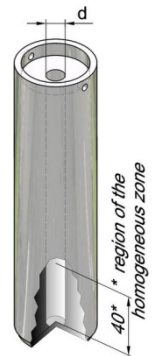

#### Inserting:

- ↪ The appropriate adapter sleeve is inserted into the metal block with the aid of the sleeve exchange tool.

#### Removing and cleaning:

- ↪ Let the calibrator cool before you remove the adapter sleeve.
- ↪ Pull the adapter sleeve out of the metal block with the help of the sleeve exchange tool.
- ↪ Clean the adapter sleeve and the metal block.



Adapter sleeves and sleeve exchange tool

This prevents the adapter sleeve from getting stuck in the metal block.

### 4.3.2 Micro bath calibrator

Type	TP M165	TP M255
Micro bath	✓	✓



#### CAUTION! Risk of injury - Wear safety goggles!

Calibration liquid can be ejected when working with the micro bath calibrator.

↳ Always wear safety goggles for the eyes when handling calibration liquids.

The micro bath is used for calibrating sensors with special shapes or dimensions. Direct contact between the sensor and the calibration liquid ensures excellent heat transfer.

The calibration liquid is poured directly into the tank or into a tub insert (→ p. 19).

The micro bath includes the transport cover, the work cover, the sensor cage, the magnetic stirrer, the draining pump, the magnetic lifter and as an accessory, the tub insert. The individual components are described below.

#### Transport cover:

The transport cover serves for secure closing of the micro bath. It prevents spillage of the calibration liquid during transport.

#### CAUTION! Safety valve!



The transport cover is equipped with a safety valve, which is activated once the pressure reaches ~1.5 bar. This can result in hot steam being released.

↳ Always unscrew the transport cover before putting the micro bath into service, in order to avoid excessive pressure.



#### Work cover:

The work cover fulfils various tasks during the operation.

- It reduces the evaporation of the calibration liquid to a minimum.
- It reduces the cooling on the surface of the calibration liquid.
- It ensures stable positioning of the test specimens in the micro bath.

The work cover is screwed on to the micro bath and has five openings for test specimens. The unused openings can be closed with suitable silicone plugs.



#### Sensor cage and magnetic stirrer:

The sensor cage protects the magnetic stirrer. It prevents the sensors from blocking the magnetic stirrer. The function of stirring is ensured by the sensor cage.



**IMPORTANT! Wearing part!**

The magnetic stirrer is a wearing part.

↳ Replace worn-out magnetic stirrers (→ § 8.1 "Maintenance").

The magnetic stirrer ensures a uniform temperature distribution in the calibration liquid.



**Operation of magnetic stirrer:**

The speed of the magnetic stirrer is set via the thumb wheel (→ Fig.) next to the controller.

Set the speed to the respective maximum to achieve a thorough mixing.

- ↻ Turn the thumbwheel upwards to increase the speed.
- ↻ Turn the thumbwheel downwards to slow down the magnetic stirrer.

**Drain pump and magnetic lifter:**

The drain pump is used for pumping out the calibration liquid from the tank of the micro bath. The magnetic stirrer is removed with the help of the magnetic lifter.

Both the activities are required before another adapter sleeve or calibration insert is inserted in the calibrator.

**Tub insert (optional / accessory):**

We recommend using a tub insert if you frequently work with different calibration liquids.

The tub insert is placed into the tank with the help of the sleeve exchange tool.

Just like the tank, the tub insert can be closed with the associated cover. Both threaded covers are leak proof, so the calibration liquid can be left in the tank or the tub insert during transport.

**4.3.2.1 Notes on the calibration liquid**

Different calibration liquids supply varying calibration results due to their specific characteristics. Adjustment to the respective calibration liquid has to be carried out by the manufacturer.

In order to achieve the best possible accuracy of a micro bath, it has to be filled with a suitable calibration liquid (→ § 2.1 "Safety instructions for the application of calibration liquids").

The calibration liquid is poured directly into the tank or into a tub insert.

**When using water as the calibration liquid:**

- ↻ Only use distilled water, otherwise excessive limescale and soiling will build up in the tank.

**When using silicone oil as the calibration liquid:**

- ↻ Wear safety goggles for the eyes without fail when working with silicone oil!
- ↻ Use only the silicone oil recommended here.

- ↪ Always read the safety data sheet supplied with the silicone oil before using it.
- ↪ Always ensure adequate ventilation when working with silicone oil, since hazardous substances can be released.
- ↪ Spilled or leaked silicone oil results in an extreme danger of slipping. Clean the affected ranges by suitable means.
- ↪ Since silicone oil is hygroscopic, always use the associated transport cover to close the tank or the tub insert after use.

#### IMPORTANT NOTICE!



Only use clean calibration liquid. Checking temperature sensors and other temperature detection means can lead to a contamination of the calibration liquid. This contamination can lead to smeary gel effect on the bottom of the tank due to the rotation of the magnetic stirrers.

- ↪ Clean the tank.
- ↪ Clean before calibration the sensors.
- ↪ Exchange the worn magnet stirrer.
- ↪ Exchange dirty, smeary calibration fluid.

#### 4.3.2.2 Information on filling amounts

##### **CAUTION! Risk of incorrect measurement or material damage!**

##### **Do not exceed the maximum fill level during operation!**



- Above the maximum fill level the heat dissipation is too great, preventing compliance with the specified tolerances.
- Overflow of the calibration liquid causes contamination and can damage the calibrator.

↪ Ensure that the maximum fill level is not exceeded during operation.

The fill level in the tank or tub insert rises as a result of

- Thermal expansion  
Calibration liquids expand to varying degrees as a result of heating. The increase in fill level depends on the calibration liquid that is used and the reference temperature setting.
- Displacement by sensors  
The volume displaced by the sensors being calibrated must be taken into account in the filling amount.
- Rise due to stirring  
The rotation of the magnetic stirrer forms a whirlpool in the liquid. This raises the fill level at the wall.

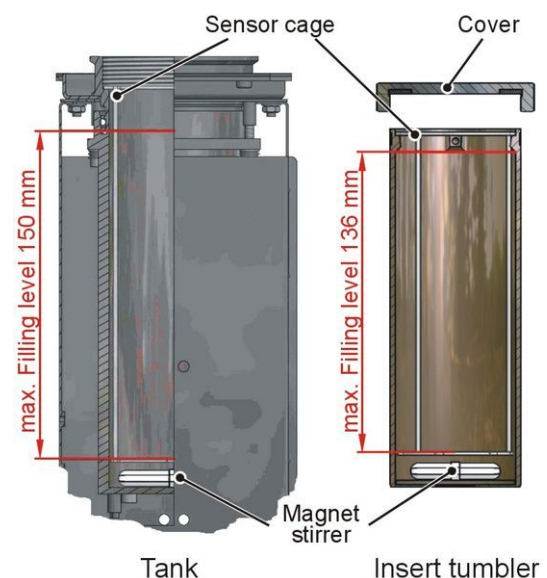

max. fill level of the micro bath

**Tank:**

The maximum fill level in the tank is displayed by the upper edge of the aluminium lining.

The maximum fill level is ~0.45 litres.

**Tub insert:**

The maximum fill level with the tub insert is below the fixture for the sleeve exchange tool.

The maximum fill level is ~0.32 litres.

**4.3.2.3 Filling the micro bath \*1**

IMPORTANT! Pay attention to § 4.3.2.2 "Information on filling amounts"!

↪ When filling, leave enough room for thermal expansion, displacement by sensors and level rise due to stirring.

- ↪ Screw on the cover of the tank/ tub insert.
- ↪ Insert the tub insert in the tank using the sleeve exchange tool (only for tub insert).
- ↪ Place the magnetic stirrer in the tank / tub insert.
- ↪ Insert the sensor cage.
- ↪ Insert the test specimens in the sensor cage.  
This accounts for the volume of the sensors to be tested.
- ↪ Fill the calibration liquid in the tank / tub insert.  
Leave sufficient reserve space for an additional rise in the level.
- ↪ If necessary, remove the test specimens again.
- ↪ Screw the work cover onto the tank and insert the sensors through the work cover into the tank or tub insert.



\*1 For tubs already filled, some steps are not required.

## 4.4 Switching on, cool down and switching off



### IMPORTANT!

Follow the instructions and notes of the section (→ § 4.1).

For reasons of safety, upon switching on the calibrator, the fan runs at the fastest speed. As soon as the internal reference has measured a safe block temperature, the fan speed is adjusted.

### Switching on:

- ↪ Turn on the main switch.
  - The controller is initialised.
  - tESt appears in the upper display.
  - The version number e.g. rL 2.2 appears on the lower display.

Initialization is completed after approx. 5 seconds and the **calibration mode** (→ § 5.2) is automatically displayed.

- The installed heating elements automatically adjust the metal block from the room temperature to the set temperature set at the controller.

IMPORTANT! Keep in mind after transport or storage!



After transport, storage or long periods of non-use, moisture can seep into the heating elements (magnesium oxide).

For drying, the calibrator must be slowly heated up. During this process, the calibrator has not yet reached the required insulation voltage for protection class I.

- ↪ For drying the heating elements, heat the calibrator for at least 15 min to 120 °C.

### Cool down the calibrator:

#### CAUTION! Risk of burns!

The calibrator can become very hot when in operation. Touching hot parts can result in serious injuries.



- ↪ Never touch the metal block, the tank, the adapter sleeve or the test specimen at temperatures above 35 °C or below 10 °C.
- ↪ In order to cool down the metal block / calibration liquid quickly, set the set temperature to a low temperature, e.g. room temperature.

The installed fan gently and automatically switches to a higher speed for heating instruments, thus providing more cooling air. The LED OUT 2 indicates the status of the output for the fan control. If the LED OUT 2 lights up, the fan is running at high speed. If the LED OUT 2 does not light up, the fan is running at low speed.

The controller switches the active cooling on for heating / cooling instruments. The LED OUT 2 indicates the status of the output for the active cooling. If the LED OUT 2 lights up, the active cooling is running. If the LED OUT 2 does not light up, the cooling is not active.



**IMPORTANT!** Mains failure or separation from the mains!



If there is a mains failure, or if the main switch is turned off, or upon removal of the mains connection ("EMERGENCY STOP"), the built-in fan does not blow any more cooling air.

Sufficient thermal de-coupling between the metal block, the tank and the housing is nonetheless guaranteed

### Switching off:

#### **CAUTION! Before switching off, pay attention to the block temperature!**



The calibrator should first reach a low block temperature before switching off. When switching off at high temperatures, the calibrator or the test specimen may be damaged.

↪ Switch off the calibrator only when the metal block or tank has reached room temperature.

- ↪ Check whether the metal block / tank has cooled down to room temperature.
- ↪ Switch off the calibrator via the main switch.
- ↪ Disconnect the calibrator from AC power if no further testing is required.  
Unplug the power cord from the wall outlet.
- ↪ Clean the calibrator after use (→ § 8.2).

## 4.5 Operating modes

During operation, there are three operating modes:

#### **Calibration mode:**

This is the normal operating mode in which the calibration of test specimens is carried out. (→ § 5.2).

#### **Set point mode:**

The set temperatures can be entered in this mode (→ § 5.3).

#### **Main menu:**

All the settings can be carried out in this mode, e.g. pre-setting the set temperatures or setting the control parameters. (→ § 5.4).

## 5 Operation

You operate the calibrator via the controller. Depending on the calibrator type, you operate the calibrator additionally via the thumbwheel of the magnetic stirrer.

The controller is equipped with two 4-digit LED displays for reference and set temperature as well as with indicators and control elements which are described in the following section.

### 5.1 Control elements of the controller (controller type K32SK)

Overview and function of the control elements of the controller:



#### 1 - Upper display (red)

- Display of current reference temperature.
- Display of individual modes, menu items and parameter.

#### 2 - Lower display (green)

- Display of set temperature.
- Display of heating / cooling capacity.
- Display of operating duration.
- Display of certain parameters in individual modes and menu items.

#### 3 - LED SET

- When flashing, it indicates access to individual menu items and parameters.

#### 4 - P key

- Switching to set point mode.
- Access to menu items and parameters.
- Input confirmation.

#### 5 - ▼ key

- Reducing values to be set.
- Selection of individual menu items.
- Return to previous menu level.

#### 6 - ▲ key

- Increasing values to be set.
- Display of current heating capacity in %.
- Selection of individual menu items.
- Return to previous menu level.

#### 7 - U key

- Retrieve saved set temperatures (only for S version).

#### 8 - LED OUT 1

Indicates the status of the output for the temperature control:

☀ If LED OUT 1 is lit, the calibrator or micro bath is heating.

● If LED OUT 1 is not lit, the calibrator or micro bath is not heating.

#### 9a - LED OUT 2

a) Heating instrument

Indicates the status of the output for the fan control:

☀ If LED OUT 2 is lit, the fan is running at high speed.

● If LED OUT 2 is not lit, the fan is running at low speed.

#### 9b - LED OUT 2

b) Heating and cooling instrument

Indicates the status of the output for the temperature control:

☀ If LED OUT 2 is lit, the calibrator or micro bath is cooling.

● If LED OUT 2 is not lit, the calibrator or micro bath is not cooling.

## 5.2 Calibration (calibration mode)

As soon as the calibrator has been switched on, it switches to the **calibration mode** after initialization

### 5.2.1 Display of reference and set temperature

The current reference temperature is displayed in the upper and the set temperature in the lower of the display.

#### Upper display (red):

The red display shows the current temperature of the metal block or of the calibration liquid.

The red display also shows the selected function alternately to the temperature if the calibrator has several functions.

#### Lower display (green):

The green display shows the current set temperature chosen by the user.

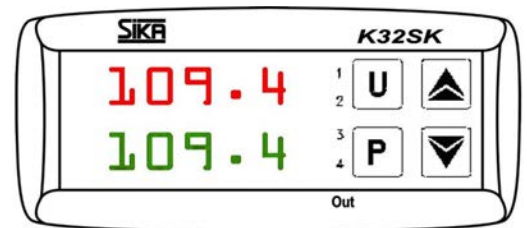

Display of reference and set temperature

### 5.2.2 Display of temperature control

The LED **OUT 1** indicates the status of the temperature control:

- If LED OUT 1 is lit the temperature control is active. The heating or cooling is switched on.
- If LED OUT 1 is not lit the heating or cooling is switched off.

If the LED OUT 1 lights up permanently, the calibrator is heating up. The temperature control is active so that the set point is reached as quickly as possible.

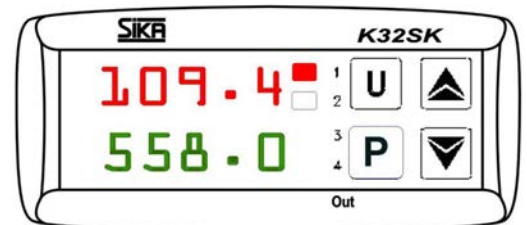

Temperature control active

If the set temperature has almost been reached, the LED OUT 1 begins to flash.

The temperature control is activated at increasingly shorter intervals. Thereby, a too strong overdriving is prevented.

To ensure good temperature stability, the cycle time of the controller is set low.

The temperature control is now often activated but only for a short time.

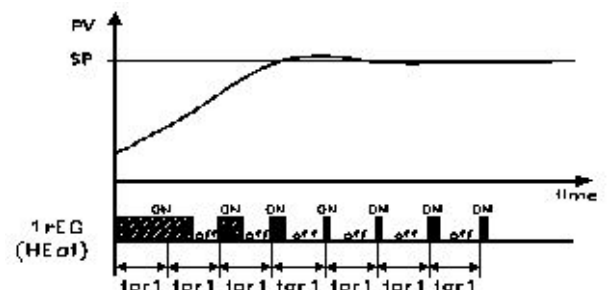

The control is done by PID algorithm.

### 5.2.3 Display of fan/ cooling control

The LED **OUT 2** indicates the status of the output for the fan / cooling control:

a) Heating instrument

The LED **OUT 2** indicates the status of the output for the fan control:

- If the LED OUT 2 is lit the fan is running at high speed.
- If the LED OUT 2 is not lit the fan is running at low speed.

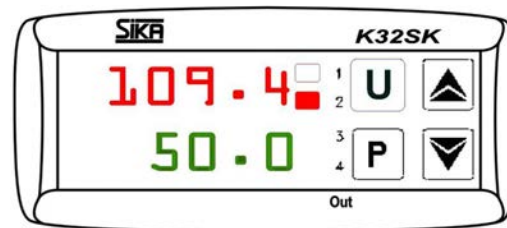

Fan / cooling control active

b) Heating and cooling instrument

The LED **OUT 2** indicates the status of the output for the cooling control:

- If LED OUT 2 is lit the temperature is decreased.
- If LED OUT 2 is not lit the cooling is switched off.

There are two ways to set the set temperature: Either you set a temporary set temperature (→ § 5.3) or you save the fixed set temperatures in the main menu (→ § 5.4).

### 5.2.4 Display of heating / cooling capacity and operating duration

In calibration mode, you can check the heating or cooling capacity and the operating duration of the calibrator. The current values of the calibrator appear on the lower display (green).

#### Heating or cooling capacity:

- ↵ Hold down the ▲ key.
  - The current heating and cooling capacity is displayed in % of the maximum capacity. "H" indicates the heating capacity and "C" indicates the cooling capacity.

#### Operating duration:

- ↵ Briefly press the ▼ key.
  - The current number of operating hours of the calibrator is displayed for ~5 s.

### 5.2.5 ConF menu

In the **ConF** menu, system parameters of the calibrator can be set. These settings may only be carried out by authorised SIKA personnel.

This menu is protected by a password.

#### CAUTION! Material damage!

The **ConF** menu is protected by a password. Unauthorised access can cause damage to the calibrator.



- ↵ Do not try to guess the password.
- ↵ Exit the menu by pressing the **P** key twice or select another menu item with the ▲ or ▼ key.

### 5.3 Set a temporary set temperature (set point mode)

In this operating mode it is possible to temporarily modify a saved set temperature.

- ↪ Press the P key shortly.  
The currently active set point memory, e.g. SP 2 (set point 2), is displayed by the upper display.  
The respective set temperature is displayed by the lower display.
- ↪ Press the ▲ key to increase the set temperature.  
Press the ▼ key to decrease the set temperature.
- ↪ Press the P key again to confirm the new set point.

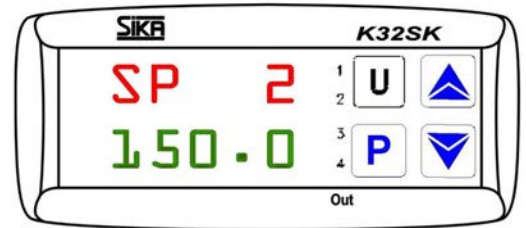

Temporary set temperature setting

#### NOTES:



- Press the ▲ and ▼ key to raise and lower the value by 0.1 respectively. If the keys are held pressed for at least one second, the value increases or decreases quickly and after two seconds even more quickly; this means the desired value can be reached rapidly.
- If no key is pressed in the **set point mode** for approx. 15 seconds, the device automatically returns to the **calibration mode**.

## 5.4 Main menu

All the settings can be carried out in this menu structure.

- ↪ Press the **P** key for approx. 5 seconds. The main menu opens.
- ↪ Use the **▼** and **▲** keys to select the desired main menu (see overview).
- ↪ Press the **P** key to confirm the selected menu item.

### Main menu for basic calibrators:

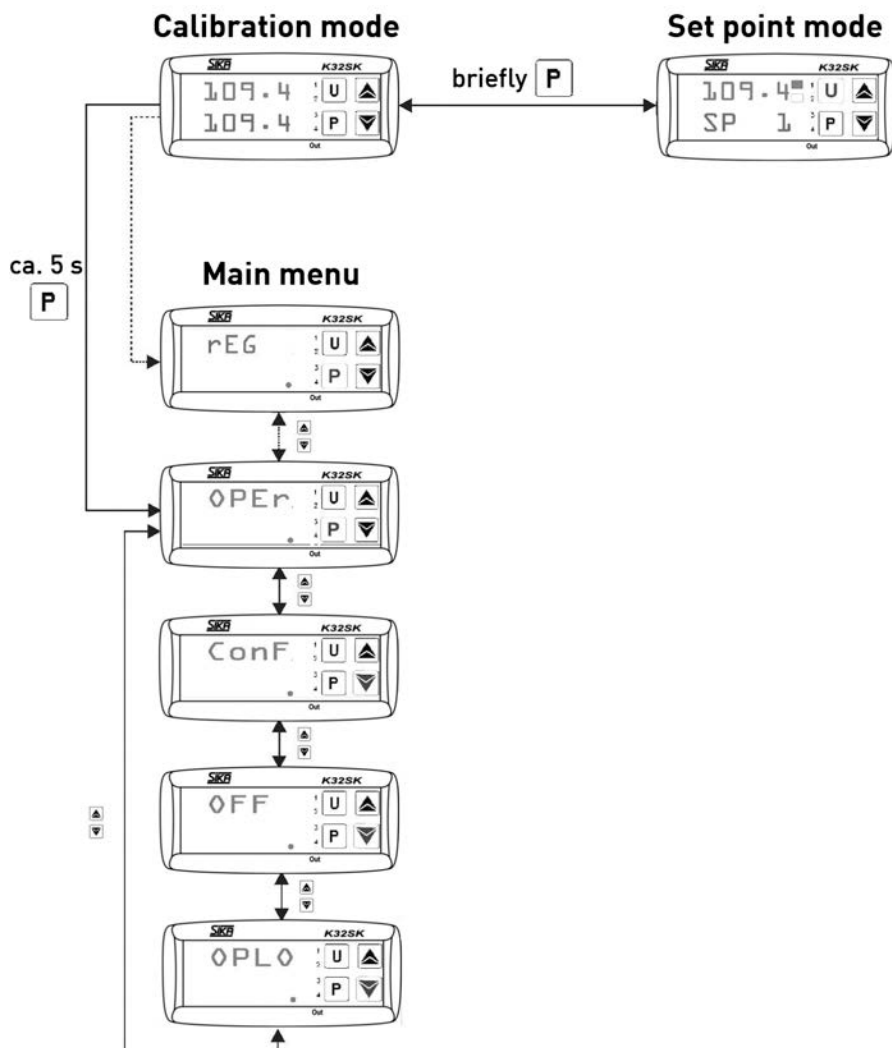

Main menu for basic temperature calibrators



### NOTICE!

The S version provides certain additional functions, e.g. storage of four different set temperatures or setting of the control parameters.

**Main menu for TP ...S and TP M...S:**

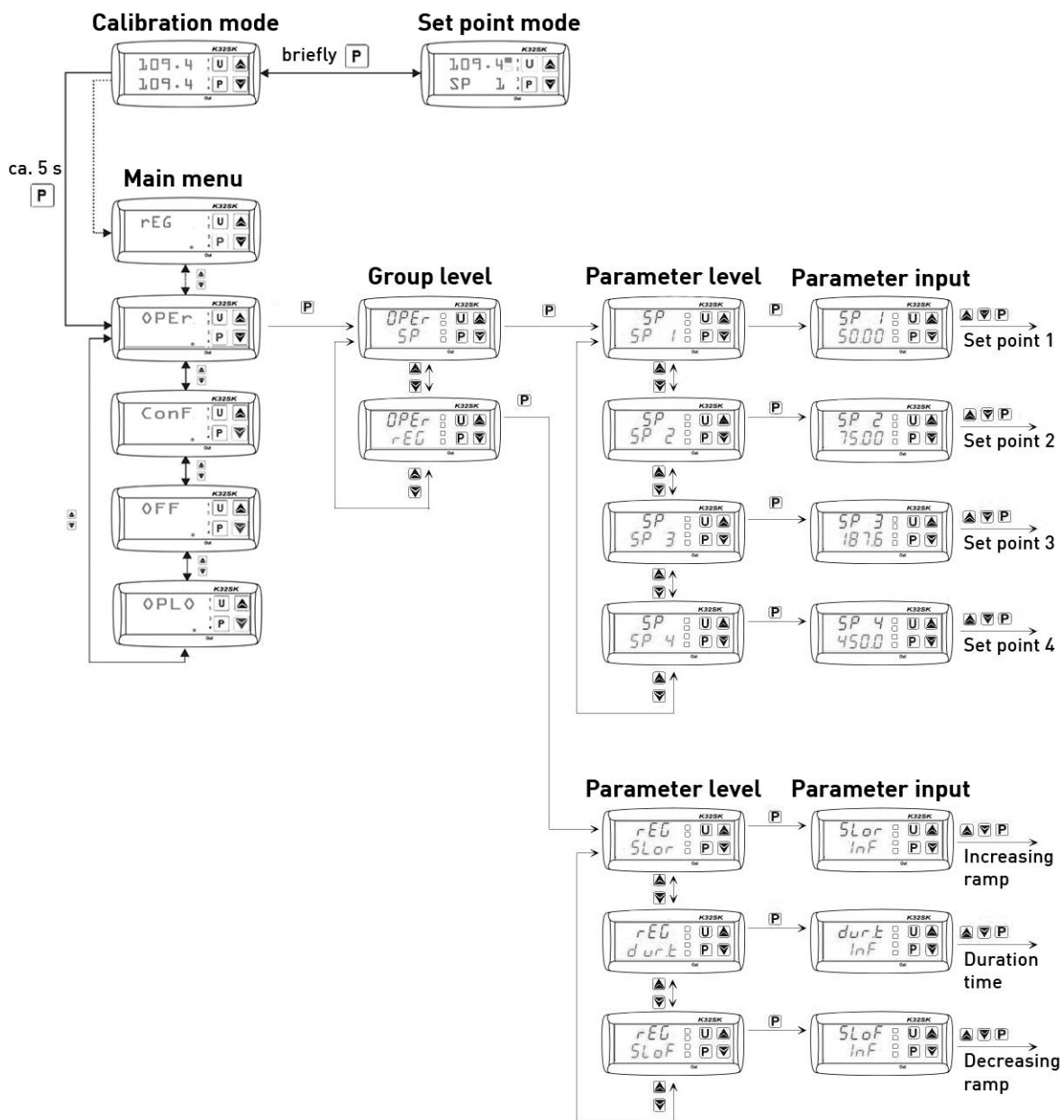

Menu structure S... versions

As displayed by the menu structure, it is possible to reach the **group** and **parameter levels** to carry out settings via **OPEr**.



**PLEASE OBSERVE:**

Many of the described settings can only be carried out in the S version, but this is displayed in the chapter heading.

**Returning to another level**

If no key is pressed in the **main menu** at the **group** or **parameter level** for approx. 15 seconds, the device automatically returns to the previous level up to the **calibration mode**.

You can also return to a previous level by pressing and holding the ▼ or ▲ key.



### 5.4.1 Automatic control

For certain tasks it can be advantageous to switch off the control, e.g. to carry out settings at the calibrator / micro bath.

#### Switching off automatic control:

- Press the **P** key when in calibration mode for approx. 5 sec., the main menu opens.  
The last selected function appears on the upper display.  
LED SET flashes on the lower display.

- Press the **▲** or **▼** key until **OFF** appears.

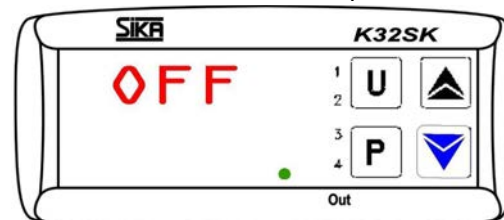

Menu control OFF

- Press the **P** key to confirm.  
An alternating display of the current reference temperature and **OFF** appears on the upper display.  
The current set temperature appears on the lower display

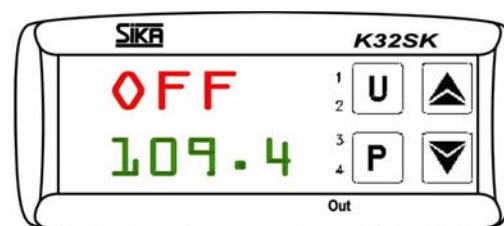

Control OFF setting display



#### TAKE NOTICE OF:

The controller is now switched off and the reference temperature will continuously change and adjust to the room temperature without having to be further regulated.

#### Switching on the automatic control:

The control is switched off if the following display appears:

An alternating display of the current reference temperature and **OFF** appears on the upper display.  
The current set temperature appears on the lower display.

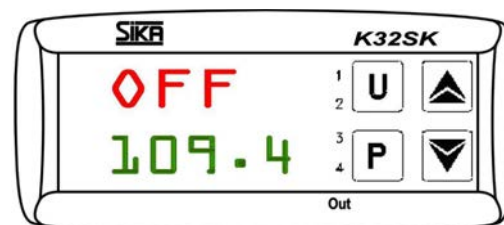

Control OFF setting display

Switch the control back on by

- pressing the **P** key for approx. 5 sec., the main menu opens.  
**OFF** appears on the upper display.  
LED SET flashes on the lower display.
- Confirm switching on the controller by pressing the arrow key until the desired operating mode is displayed and confirm this with the **P** key.

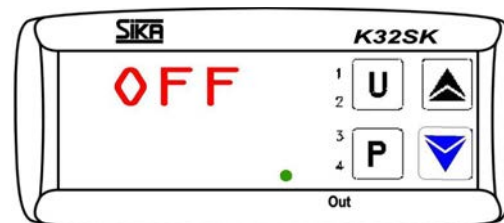

OFF display



#### PLEASE NOTE:

The control has been reactivated. The calibrator / micro bath is in calibration mode and the set temperature is targeted.

## 5.4.2 Manual control

### Switching on the manual control:

It is possible to switch off the automatic control of the calibrator / micro bath and to achieve the desired temperature via manual control.

- Press the **P** key for approx. 5 sec., the main menu opens. The last selected function appears on the upper display.  
LED SET flashes on the lower display.

- Press the **▲** or **▼** key until **OPLO** appears.

**OPLO** appears on the upper display.  
LED SET flashes on the lower display.

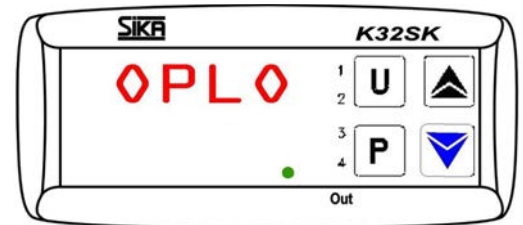

Menu manual control OPLO

- Press the **P** key to confirm.  
The current reference temperature appears on the upper display.  
The letter H and the currently set output capacity in % appear on the lower display.

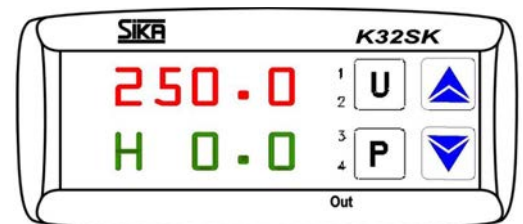

Manual control OPLO setting display

- Press the **▲** key, to **increase** the output capacity.
- Press the **▼** key, to **decrease** the output capacity.



#### PLEASE NOTE:

Press the **▲** and **▼** key to raise and lower the value by 0.1% respectively. If the keys are held pressed for at least one second, the value increases or decreases quickly and after two seconds even more quickly; this means the desired value can be reached rapidly.

### Switching off the manual control:

The manual control is switched on if the following display appears:

The current reference temperature appears on the upper display.  
The letter H and the currently set output capacity in % appear on the lower display.

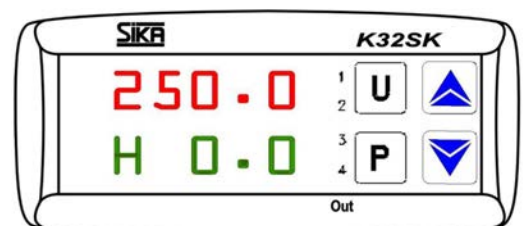

Manual control OPLO setting display

Switch the manual control off again by

- pressing the **P** key for approx. 5 sec., the main menu opens.  
**OPLO** appears on the upper display.  
LED SET flashes on the lower display.
- Confirm switching on the automatic controller by pressing the arrow key until the desired operating mode is displayed and confirm this with the **P** key.

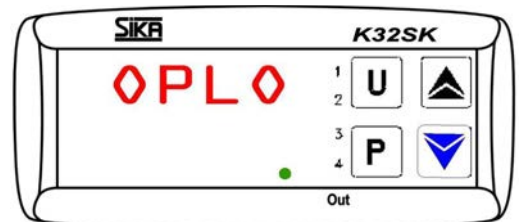

OPLO display

### 5.4.3 Set point memory (S version)

#### Setting and saving fixed set temperatures (S version)

In order to save set temperatures in the calibrator / micro bath, the respective set point memory has to be opened

- ↪ Press the **P** key for approx. 5 sec. when in **calibration mode**, the main menu opens. **OPEr** appears on the upper display. LED SET flashes on the lower display.
- ↪ Press the **P** key again, the **group level** opens. **OPEr** appears on the upper display. 'SP' appears on the lower display and LED SET flashes.
- ↪ Press the **P** key again, the **parameter level** opens. 'SP' appears on the upper display. The set point memory SP 1 and LED SET flash on the lower display.
- ↪ Use the ▲ or ▼ key to select one of the four set point memories SP1, SP2, SP3 and SP4.
- ↪ Press the **P** key to open the respective set point memory. The selected set point memory, e.g. SP 3 flashes on the upper display. The corresponding current set temperature appears on the lower display.
- ↪ Press the ▲ key to **increase** the set temperature.
- ↪ Press the ▼ key to **decrease** the set temperature.

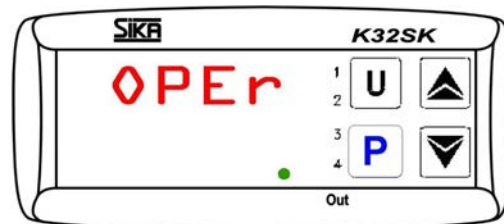

operator menu OPEr

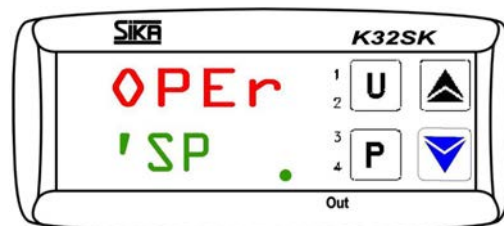

Group SP

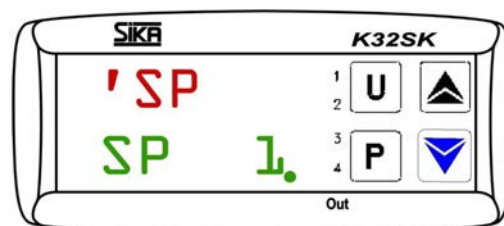

Parameter for the set memory SP1

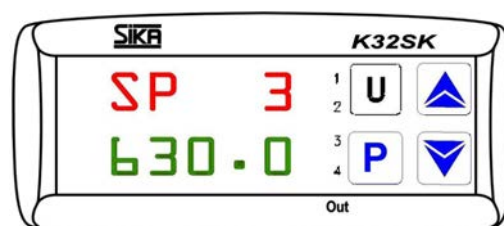

Set point memory SP3 entry



Press the ▲ and ▼ key to raise and lower the value by 0.1 respectively. If the keys are held pressed for at least one second, the value increases or decreases quickly and after two seconds even more quickly; this means the desired value can be reached rapidly.

- ↪ Press the **P** key to confirm the set temperature. The set point memory closes and the display returns to the **parameter level**.
- ↪ Press and hold the ▼ or ▲ key to return to the **calibration mode**.

If no key is pressed for approx. 15 seconds, the device automatically returns to a previous level up to the **calibration mode**.

**Retrieving the saved set temperatures (S version):**

The saved set temperatures can be retrieved in calibration mode.

- ↪ Press the **U** key for approx. 2 sec., the current set point memory opens.  
The current reference temperature appears on the upper display.  
The set point memory SP... appears on the lower display for 2 sec. followed by the current set temperature.

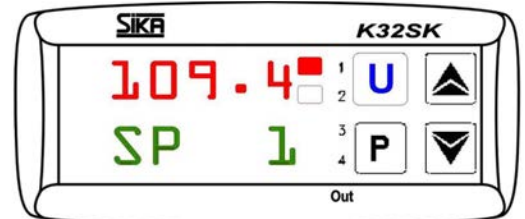

- ↪ To receive another saved set point SP1, SP2, SP3 or SP4, press the **U** key again.



Retrieving the set temperatures display

The selected temperature value is immediately adopted and targeted.

**5.4.4 Gradient control / temperature profile (S version)**

It is possible to carry out a gradient control yourself and thus determine the time in which the set temperature is reached. The time can be shorter or longer than the time usually required by the calibrator / micro bath.

When modifying the set temperature or switching on the calibrator / micro bath it is automatically determined which of the gradients (heating gradient "SLor" or cooling gradient "SLoF") is to be used.

Additionally, you can ensure that the calibrator / micro bath switches to the set temperature in set point memory SP2 as soon as the set temperature in set point memory SP1 has been achieved and after a programmed duration time "dur.t"; this creates a simple temperature profile.

After switching on the calibrator / micro bath the temperature profile is automatically carried out.

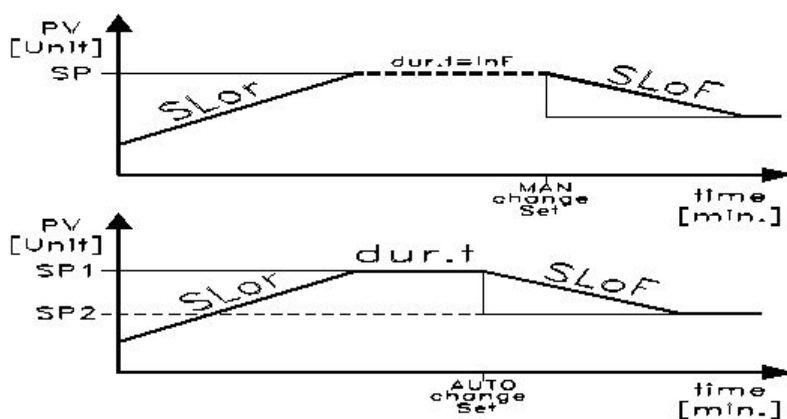

Gradient control and temperature profile

## Setting values for „SLor“ and „SLoF“

Calibrator type	Heating gradient <sup>1)</sup> „SLor“	Cooling gradient <sup>2)</sup> „SLoF“	
<b>Heating/Cooling:</b>			
<b>TP 17165 S</b>	< 7 °C/min	< 5 °C/min	
<b>TP 17166S /TP 17200S</b>	< 3 °C/min	< 4 °C/min	
<b>TP M165S</b> - with silicone oil 10CS - with distilled water	< 3 °C/min < 5 °C/min	< 6 °C/min < 4 °C/min	
<b>Heating:</b>			
<b>TP 17450S, TP 17650S</b>	< 35 °C/min	max. ... 300 °C 300 °C ... 100 °C	< 10 °C/min < 5 °C/min
<b>TP M255S</b> - with silicone oil 20CS - with distilled water	< 22 °C/min < 12 °C/min	200 °C ... 50 °C 50 °C ... 30 °C 90 °C ... 50 °C 50 °C ... 30 °C	< 4 °C/min < 0,5 °C/min < 2 °C/min < 0,5 °C/min

**<sup>1)</sup> Heating gradient „SLor“:**

The heating gradient "SLor" is active if the reference temperature is lower than the set temperature. Each calibrator type has a max. heating capacity, meaning that only settings < than this heating capacity are reasonable and extend the time until the set temperature is achieved.

**<sup>2)</sup> Cooling gradient „SLoF“:**

The cooling gradient "SLor" is active if the reference temperature is higher than the set temperature. Only settings below the cooling capacity of the calibrator have an effect on the cooling gradients.

**Duration time „dur.t“:**

The duration time "dur.t" is active if the set temperature SP1 has been achieved. Subsequently, the calibrator / micro bath automatically switches to set temperature SP2.

**ACTIVATE TEMPERATURE PROFILE!**

If you have carried out settings for these three settings, the calibrator / micro bath uses the new values only when modifying the set temperature or switching the calibrator off and on again.

A further procedure is to switch off the automatic control prior to modifying parameters and to switch it on again afterwards (→ § 5.4.1).

The heating and cooling gradients and the duration time can be set in the parameter level **'rEG**.

↪ Pressing the **P** key for approx. 5 sec., the main menu opens.  
The last selected function appears on the upper display.  
LED SET flashes on the lower display.

↪ Press the **▲** or **▼** **key** until **OPEr** appears.

↪ Press the **P** key again, the **group level** opens.  
**OPEr** appears on the upper display.  
**'SP** appears on the lower display and LED SET flashes.

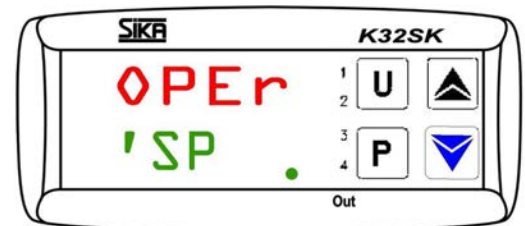

Group 'SP

↪ Use the **▼** key to select the group **'rEG**.  
**OPEr** appears on the upper display.  
**'rEG** appears on the lower display and LED SET flashes.

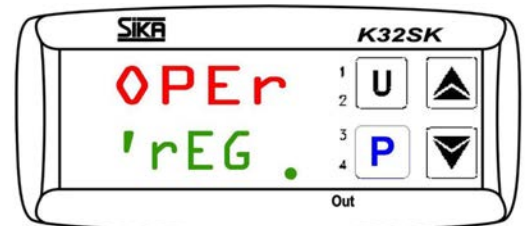

Group 'rEG

↪ Press the **P** key again, the **parameter level** opens.

**'rEG** appears on the upper display.  
**SLor** flashes on the lower display

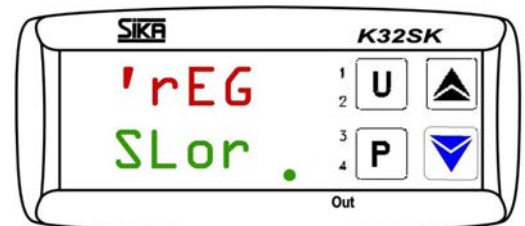

Parameters for heating gradient SLor

#### 5.4.4.1 Setting the heating gradient (S version)

The heating gradient "**SLor**" is active if the reference temperature is lower than the set temperature.

The setting range extends from 99.99 °C/min up to 0.00 °C/min.



PLEASE NOTE:

The function is deactivated if SLor = InF (In no Function) has been set.

You are in the **parameter level**.

'rEG appears on the upper display.

SLor flashes on the lower display.

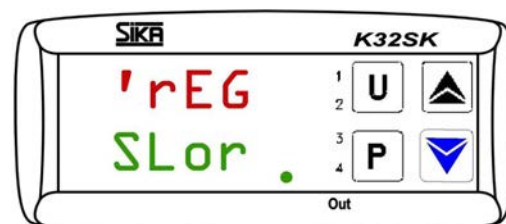

Parameters for heating gradient SLor

➤ Press the **P** key.

**SLor** flashes on the upper display.

The respective **currently set heating gradient** appears on the lower display.

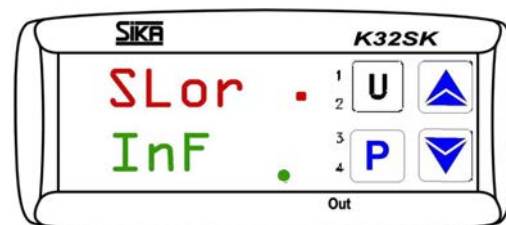

Heating gradient entry

➤ Press the **▲** key to **increase** the heating gradient **SLor**.

Press the **▼** key to **decrease** the heating gradient **SLor**



Press the **▲** and **▼** key to raise and lower the value by 0.1 respectively. If the keys are held pressed for at least one second, the value increases or decreases quickly and after two seconds even more quickly; this means the desired value can be reached rapidly.

➤ Press the **P** key to confirm the set heating gradient **SLor**.

The display returns to the parameter level and you can set the other parameters.

Automatic return!

If no key is pressed for approx. 15 seconds, the device automatically returns to a previous level up to the **calibration mode**.



Activate temperature profile!

After carrying out the settings, the calibrator uses the new values only when modifying the set temperature or switching the calibrator / micro bath off and on again.



### 5.4.4.2 Setting the cooling gradient (S version)

The cooling gradient "SLoF" is active if the reference temperature is higher than the set temperature.

The setting range extends from 99.99 °C/min up to 0.00 °C/min.



PLEASE NOTE:

The function is deactivated if SLoF = InF (In no Function) has been set.

You are in the **parameter level**.

'rEG appears on the upper display.  
SLor flashes on the lower display.

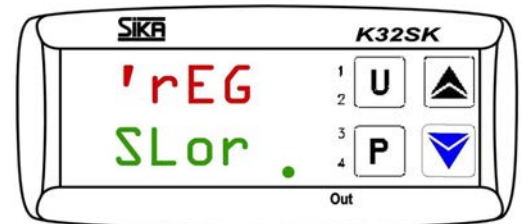

Parameters for heating gradient SLor

Use the **▼** or **▼** key to select the parameter **SLoF**.

'rEG appears on the upper display.  
SLoF flashes on the lower display

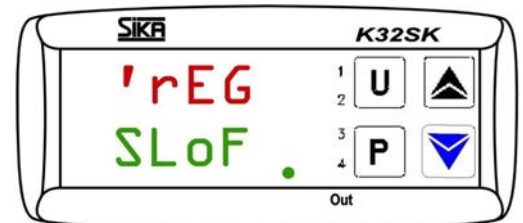

Cooling gradient entry

Press the **P** key.

SLoF flashes on the upper display.  
The respective **currently set cooling gradient** appears on the lower display.

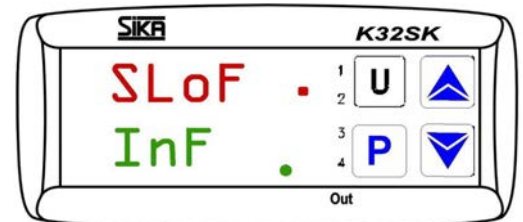

Display of the cooling gradient input

Press the **▲** key to **increase** the cooling gradient **SLoF**.

Press the **▼** key to **decrease** the cooling gradient **SLoF**.



Press the **▲** and **▼** key to raise and lower the value by 0.1 respectively. If the keys are held pressed for at least one second, the value increases or decreases quickly and after two seconds even more quickly; this means the desired value can be reached rapidly.

Press the **P** key to confirm the set cooling gradient **SLoF**.

The display returns to the parameter level and other parameters can be set.

Automatic return!

If no key is pressed for approx. 15 seconds, the device automatically returns to a previous level up to the **calibration mode**.



Activate temperature profile!

After carrying out the settings, the calibrator / micro bath uses the new values only when modifying the set temperature or switching the calibrator / micro bath off and on again.

### 5.4.4.3 Setting the duration time (S version)

The duration time "**dur.t**" is active if the set temperature SP1 has been achieved. Subsequently, the calibrator / micro bath automatically switches to set temperature SP2. The setting range extends from 99:59 [hh:min] to 00:00 [hh:min].



PLEASE NOTE:

The function is deactivated if dur.t = InF (In no Function) has been set.

You are in the **parameter level**.

'rEG appears on the upper display.  
SLor flashes on the lower display.

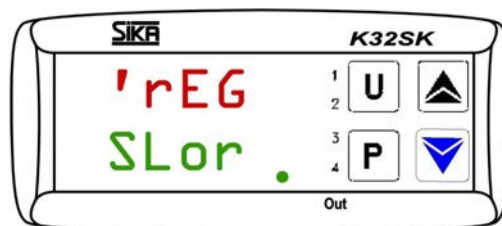

Parameters for heating gradient SLor

Use the ▼ or ▼ key to select the parameter **dur.t**.

'rEG appears on the upper display.  
SLoF flashes on the lower display

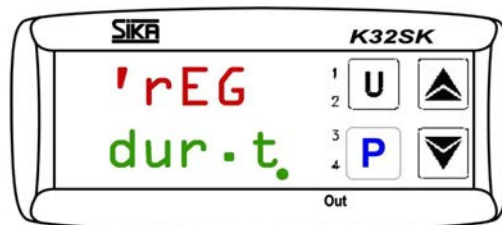

Parameters for the duration time dur.t

➤ Press the **P** key.  
**dur.t** flashes on the upper display.  
The respective **currently set duration time** appears on the lower display.

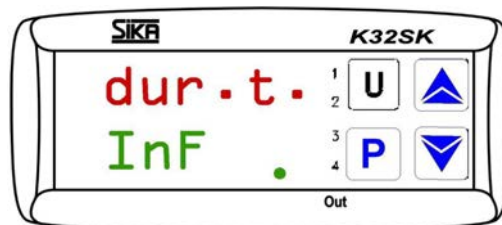

Duration time entry

➤ Press the ▲ key to **increase** the duration time **dur.t**.  
➤ Press the ▼ key to **decrease** the duration time **dur.t**.



Press the ▲ and ▼ key to raise and lower the value by 0.1 respectively. If the keys are held pressed for at least one second, the value increases or decreases quickly and after two seconds even more quickly; this means the desired value can be reached rapidly.

➤ Press the **P** key to confirm the set duration time dur.t.  
The display returns to the parameter level.

Automatic return!

If no key is pressed for approx. 15 seconds, the device automatically returns to a previous level up to the **calibration mode**.



Activate temperature profile!

After carrying out the settings, the calibrator / micro bath uses the new values only when modifying the set temperature or switching the calibrator / micro bath off and on again.

## 6 Testing process / Calibration

### CAUTION! Risk of burns!

The calibrator can become very hot when in operation. Touching hot parts can result in serious injuries.



- ↪ Never touch the metal block, the tank, the adapter sleeve or the test specimen at temperatures above 35 °C or below 10 °C.
- ↪ Allow the calibrator to cool before you remove the test specimen, clean the tank, change the adapter sleeve or the calibration insert or switch off the machine.

### 6.1 Testing temperature sensors

A separate temperature measuring instrument connected to the test specimen is required to test the temperature sensors

By comparing the temperature displayed at the external measuring instrument with the reference temperature it is possible to assess the status of the test specimen. Remember that the test specimen requires a short period of time until it absorbs the temperature of the metal block or liquid bath.

The internal reference is set to normal when operating the micro-bath and the dry block.



### CAUTION! Incorrect results!

It is not possible to calibrate earthed thermal elements, because the heating block is earthed and any measurement would produce incorrect results.

### 6.2 Testing process

#### Before the testing process:

Before the start of the testing process, check whether

- the instructions regarding the installation site and the operational position have been complied with (→ § 4.1).
- the electrical connections have been made correctly (→ § 4.2).
- the correct measuring insert has been selected for the testing process (→ § 4.3).
- the test specimen is securely fixed in the calibrator.
- the calibrator has sufficient structural stability.

**Performing testing process:**

During the testing process, one or more test points are approached and the reference temperature of the calibrator is compared with the measured temperature of the specimen.

- ↪ Set the set temperature to the value of the first test point.
  - The temperature control regulates the metal block or the calibration fluid to the temperature of the test point.
- ↪ Wait until the temperature has been reached and is sufficiently stable for your checking.
  - ⚠ Also note that the temperature of the specimen is stable and transients are finished.
- ↪ Write down the reference temperature and the temperature of the specimen for your test protocol.
- ↪ Set the calibrators gradually to the set values of the further test points and proceed as described above.

**Terminate / cancel testing process:**

If the testing process has to be terminated or cancelled, the calibrator must be brought in a safe operational state.

- ↪ Set the set temperature to a low value e.g. room temperature.
- ↪ Wait until the calibrator has sufficiently cooled down.
  - ⚠ Don't let the calibrator unattended at high temperatures.

**After the testing process:**

- ↪ Allow the calibrator to cool to room temperature.
- ↪ Note the instructions in the section "Switching on, cool down and switching off" (→ § 4.4).
- ↪ If necessary drain the tank or tub insert of the micro bath calibrator with the drain pump.
- ↪ Clean the calibrator (→ § 8.2).

## 7 Problems

### CAUTION! Material damage!



The TP17 / TPM cannot be repaired by the user! In case of a defect, the device must be returned to the manufacturer for repair.

🔧 Never open the TP17 / TPM and perform any repair yourself.

The following table details what problems you can solve yourself and how to solve them.

Problem	Possible cause	Remedy
----	Interruption of the internal reference sensor or the internal reference sensor is defective.	The controller switches off the power supply to the heating cartridge (servicing required).
uuuu	Measured temperature under the limit value of the internal reference sensor (under range - 200 °C)	
oooo	Measured temperature above the limit value of the internal reference sensor (over range +850 °C)	
ErEP	Possible fault in the EEPROM memory of the controller	Press the P key
Fan not running	The fan is defective or blocked	The temperature switch is possibly triggered, switching off the power supply to the heating cartridge (servicing required)
End temperature is not achieved	Solid state relay is defective or the heating / cooling element has short circuited or aged	Servicing required
Sensor break.	External reference sensor not properly connected.	Recheck connection and connect properly.
	Cable break or short circuit.	Service call required.
No display	Controller defective	Servicing required
No function	Network connection not established correctly or fuse defective	Check the network connection and fuse

If you are unable to remedy any particular problem, then immediately disconnect the calibrator in order to protect it from unintended operation.

Contact your supplier or directly to SIKA. Please send the device for repair with a brief description of the problem, the environmental conditions and the length of time the device was operational before the problem occurred.

## 7.1 Return shipment to the manufacturer

Contact SIKA's department "Sales" when you have a defective calibrator within or outside the warranty to arrange the shipping of the calibrator.

Due to legal requirements placed on environmental protection and occupational safety and health and to maintain the health and safety of our employees, all units returned to SIKA for repair must be free of toxins and hazardous substances. That also applies to cavities in the devices. If necessary, the customer must neutralise or purge the unit before return to SIKA.

Costs incurred due to inadequate cleaning of the device and possible costs for disposal and/or personal injuries will be billed to the operating company.

### **WARNING! Risk of injury due to insufficient cleaning!**



The operating company is responsible for all damages and harm of any kind, in particular physical injuries (e.g. caustic burns or toxic contaminations), decontamination measures, disposal etc. that can be attributed to insufficient cleaning of the measuring instrument.

☞ Comply with the instructions below before returning the unit.

The following measures must be taken before you send the unit to SIKA for repair:

- ☞ Clean the device thoroughly. This is of extreme importance if the medium is hazardous to health, i.e. caustic, toxic, carcinogenic or radioactive etc.
- ☞ Remove all residues of the media and pay special attention to sealing grooves and slits.
- ☞ Attach a note describing the malfunction, state the application field and the chemical/physical properties of the media.
- ☞ Please follow the instructions on the procedure for sending returns which are on our website ([www.sika.net/en/services/return-of-products-rma.html](http://www.sika.net/en/services/return-of-products-rma.html)) and please specify a point of contact in case our service department has any questions.

The customer must confirm that the measures were taken by filling out the declaration of decontamination. It can be found on our website as a download:

[www.sika.net/images/RMA/Formular\\_Warenruecksendung.pdf](http://www.sika.net/images/RMA/Formular_Warenruecksendung.pdf)

## 8 Maintenance, cleaning and transport

Before maintenance, cleaning and transport, check whether

- the calibrator has cooled sufficiently (→ § 4.4 "Cool down").
- the calibrator has been switched off and disconnected from the mains.

### 8.1 Maintenance

The TP17 / TPM itself is maintenance-free and cannot be repaired by the user. In case of a defect, the device must be returned to the manufacturer for repair.



#### **CAUTION! Material damage!**

When opening the device, critical parts or components can be damaged.

- ↪ Never open the device and perform any repair yourself.

For safe operation of the calibrator, the following checks must be carried out at regular intervals:

#### **Before use:**

- ↪ Check the calibrator for damage.
- ↪ For micro bath calibrators, check the filled height of the calibration liquid. When doing so, note the Information on filling amounts (→ § 4.3.2.2).

#### **Annually:**

- ↪ Subject all the parts of the calibrator to a visual inspection for corrosion, wear and damage.
- ↪ Have a trained technical person carry out a safety inspection of all the electrical parts.

#### **Recalibration:**

- ↪ Send the calibrator Recalibration (→ § 8.1.1) after 36 months or after a maximum of 500 operating hours to SIKA.

#### **Calibration liquid:**

Calibration liquids get fouled or age with time. This depends to a great extent on the type of liquid and the usage behaviour.

- ↪ Replace the fouled or aged calibration liquid.

#### **Magnetic stirrer:**

The magnetic stirrer is a wear part. The fillet in the middle reduces the friction during the rotary movement. Once the fillet has worn, the stirring function can no longer be guaranteed because of the increased friction.

- ↪ Check the fillet of the magnetic stirrer for wear and replace it in time.



**Thermal fuse:**

The thermal fuses of the calibrator are located on the front side and are integrated in the mains connection. If there is a mains voltage present, but the display is dark and the fan is not running, you should check the fuses and replace them if required.

- ↪ Pull the mains connection cable from the calibrator.
- ↪ Prise open the fuse compartment from the bottom with a fingernail or a flat screwdriver.
- ↪ Remove the compartment with the fuses.
- ↪ Check the fuses and replace the faulty fuses.
  - ⚠ **IMPORTANT!** Only use fuses of the same type (→ § 10.2...10.4).  
Always replace both fuses, even if only one is defective.
- ↪ Fit the fuse compartment back in place and connect the mains connecting cable (→ § 4.2 "Electrical connection").

Should the fuses blow repeatedly, there is probably a fault in the calibrator.

In this case, send the calibrator to SIKA for repairs (→ § 7+§ 7.1).

**8.1.1 Recalibration**

The calibrator is adjusted and tested with measuring equipment in accordance with recognized national standards prior to delivery.

The calibrator should, depending on the application situation, be inspected at appropriate intervals on the basis of DIN ISO 10012. We recommend you to return the calibrator to SIKA at intervals of max. 36 months or approx. 500 operating hours for recalibration and readjustment.

Recalibration is based on the directive DAkkS-DKD R5-4 of the German Accreditation Body. The measures described here are applied and considered during recalibration.

## 8.2 Cleaning

### External cleaning:

Clean the TP17 / TPM with a dry or slightly damp lint-free cloth. Do not use sharp objects or aggressive agents for cleaning.

Ensure that your cleaning agent cannot be a source of danger from a reaction with parts of the machine or the materials inside it.

If you have any questions regarding compatibility, please contact our customer service.

### Venting grilles for inlet air:

The grille openings ① + ② in the base of the calibrator must be cleaned at regular intervals.

The cleaning intervals depend very closely on the air pollution at the installation site and the daily operating duration.

- ↪ Clean the grille openings by vacuuming or brushing off.
- ↪ Please keep in mind the following instruction regarding the temperature fuse.

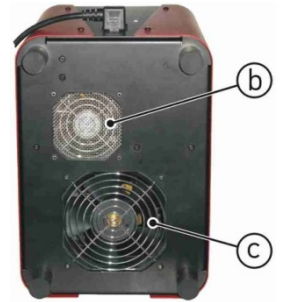

**IMPORTANT!** Temperature fuse at over-temperature!



An air flow that is too low can result in the temperature fuse getting triggered. The calibrator is then rendered operationally disabled, and must be sent to SIKA.

- ↪ Ensure that the grille openings are always clear.

### Measuring insert (Adapter sleeves and calibration inserts):

During operation, small quantities of metal dust get created. It can result in the measuring insert getting stuck in the calibration block.

- ↪ Pull the measuring insert out of the calibration block with the help of the sleeve exchange tool.
- ↪ Clean the measuring insert and the calibration block at regular intervals.



Before a prolonged shutdown of the calibrator, remove the measuring insert from the calibration block.

### Tank (Micro bath calibrator):

Before cleaning, the tank must be drained as much as possible with the draining pump. When doing so, follow the corresponding instructions in the safety data sheet of the calibration liquid used.

Distilled Water:

- ↪ Remove the sensor cage from the tank.
- ↪ Remove the magnetic stirrer with the help of the magnetic lifter.
- ↪ Dry the tank, the sensor cage, the magnetic stirrer and the draining pump thoroughly.

Silicone oil:

- ↪ Remove the sensor cage from the tank.
- ↪ Remove the magnetic stirrer with the help of the magnetic lifter
- ↪ Clean the cage, the magnetic stirrer and the tank with water to which a generous amount of rinsing liquid has been added.
- ↪ Remove the cleaning water to the maximum extent possible using the draining pump.
- ↪ Dry the tank, the sensor cage, the magnetic stirrer and the draining pump thoroughly.

### 8.3 Transport

#### **CAUTION! Risk of burns!**



The calibrator can become very hot when in operation. Touching hot parts can result in serious injuries.

- ↪ Allow the calibrator to cool down before transport.
- ↪ Carry the calibrator only at the handle.

Observe the following instructions for a safe transport of the TP17 / TPM:

- The calibrator has to cool down to room temperature.
- The calibrator is switched off and was disconnected from AC power.
- All connected sensors and devices have been removed.
- The tank of the micro bath calibrator has been closed with the transport cover.
- ↪ The calibrator must be transported upright.
  - Avoid bumps and shocks.
  - Let the calibrator neither fall nor tip over.
- ↪ Protect the calibrator from inadequate environmental influences.
  - Use our transport case which is available as accessories.
- ↪ Carry the calibrator only at the handle.

## 9 Decommissioning and disposal



### CAUTION! Risk of injury!

Never remove the device from a measurement set up in operation.

↪ Make sure that the measurement set up is shut down professionally.

### Before decommissioning:

Prior to decommissioning, ensure that

- the measurement set up is switched off and is in a safe and de-energised state.
- the calibrator and the accessories has completely cooled down (→ § 4.4 "Switching on, cool down and switching off").

### Decommissioning:

- ↪ Remove all connected sensors and devices.
- ↪ Switch off the calibrator and disconnect the mains plug
- ↪ Empty the calibrator tank in case there is residual calibration liquid (→ § 8.2 "Cleaning").

### Disposal calibration liquid:



IMPORTANT! Disposal calibration liquid!

Dispose of the calibration liquid in accordance with the Technical Safety Data Sheet.

### Disposal calibrator:

Compliant with the Directives 2011/65/EU (RoHS) and 2012/19/EU (WEEE)\*, the device must be disposed of separately as electrical and electronic waste.



### NO HOUSEHOLD WASTE!

The calibrator of the TP17 / TPM series consist of various different materials. It must not be disposed of with household waste.

↪ Take the TP17 / TPM to your local recycling plant

or

↪ send the TP17 / TPM back to your supplier or to SIKA.

\* WEEE reg. no.: DE 25976360

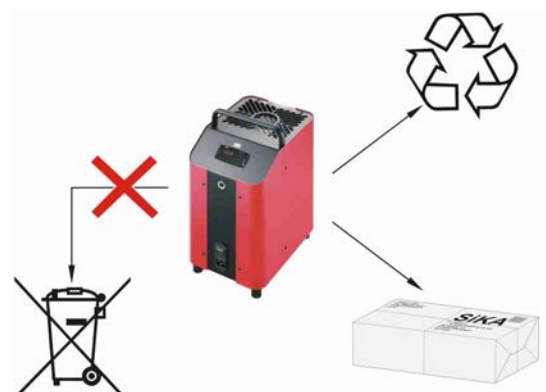

## 10 Technical data

The technical data of customised versions may differ from the data in these instructions. Please observe the information specified on the type plate.

### 10.1 Shared characteristics

Characteristics	Series	TP 17...	TP 17...S	TP M...S
<b>Calibrator</b>				
Influence of the operating temperature (0...50 °C) to the accuracy		+/- 0.02 °C/°C		
Detection speed		130 ms		
Control sensor		Internal		
<b>Display</b>				
Resolution		0.1 °C	0.01 °C (-9.99 ... 99.99), or 0.1 °C	
Display unit		°C or °F (optional)		
Two-line display: - Reference temperature - Target temperature		4-digit, 7-segment LED, 7mm high red = upper display, green = lower display		
Display for sensor break		- - - -		
<b>Electrical characteristics</b>				
Degree of protection		IP 20		
Block temperature control		via PID-controller		
Controller outputs: - Heater control - Cooler control - Fan control		voltage output for control of the solid state relay (8 mA/ 8 V <sub>DC</sub> ) voltage output for control of the solid state relay (8 mA/ 8 V <sub>DC</sub> ) relay SPDT (8 A-AC1, 3 A-AC3 / 250 V <sub>AC</sub> ) 100,000 switching cycle		
Sensor break behaviour		the control is switched off		
Excess temperature behaviour		temperature fuses interrupt the power supply if there is excess temperature inside the housing		
<b>Ambient conditions</b>				
Operating temperature		0...50 °C		
Transport and storage temperature		-10...60 °C		
Humidity (RH)		30...95 % (non-condensing environment)		
Operating conditions: - Location • Altitude - Operating position		Interiors • up to 2000 m Standing upright/vertically		

## 10.2 Characteristics TP 17... series

Characteristics	Type	TP 17165	TP 17166	TP 17200	TP 17450	TP 17650
<b>Calibrator</b>						
Temperature range		-35...165 °C	-35...165 °C	-55...200 °C	T <sub>R</sub> ...450 °C	T <sub>R</sub> ...650 °C
Accuracy		± 0.4 °C	± 0.4 °C	± 0.4 °C	± 0.6 °C	± 0.8 °C
Stability		± 0.1 °C				
Display range		-50...165 °C	-50...165 °C	-60...200 °C	0...450 °C	0...650 °C
<b>Electrical characteristics</b>						
Supply voltage:						
- 100...240 V <sub>AC</sub>		50/60 Hz			-/-	50/60 Hz
- 230/240 V <sub>AC</sub>		-/-	-/-	-/-	50/60 Hz	
- 100...115 V <sub>AC</sub> (optional)		-/-	-/-	-/-	-/-	50/60 Hz
Power consumption		375 W		555 W	2000 W	1000 W
Fuse:						
- 100...240 V <sub>AC</sub>		6.3 A slow			-/-	10.0 A slow
- 230/240 V <sub>AC</sub>		-/-	-/-	-/-	10.0 A slow	6.3 A slow
- 100...115 V <sub>AC</sub> (optional)		-/-	-/-	-/-	-/-	10.0 A slow
<b>Process variables</b>						
Test specimen holder:						
- Bore		∅ 28 mm	∅ 60 mm	∅ 28 mm	∅ 60 mm	∅ 28 mm
- Depth		150 mm				
- Measurement zone		110...150 mm				
Housing dimensions:						
- Width		210 mm			150 mm	
- Height		380+50 mm			330+70 mm	
- Depth		300 mm			270 mm	
Weight		~10.0 kg	~10.0 kg	~12.5 kg	~7.5 kg	
Sleeves for smaller ∅ (in 0.5 mm steps)		1.5...25 mm	1.5...55 mm	1.5...25 mm	1.5...55 mm	1.5...25 mm

**10.3 Characteristics TP 17...S**

Characteristics \ Type	TP 17165S	TP 17166S	TP 17200S	TP 17450S	TP 17650S
<b>Calibrator</b>					
Temperature range:					
- Dry block	-35...165 °C	-35...165 °C	-55...200 °C	T <sub>R</sub> ...450 °C	T <sub>R</sub> ...650 °C
Accuracy:					
- Dry block	± 0.2 °C	± 0.2 °C	± 0.2 °C	± 0.3 °C	± 0.4 °C
Stability:					
- Dry block	± 0.05 °C				
Display range:	-50...165 °C	-50...165 °C	-60...200 °C	0...450 °C	0...650 °C
<b>Electrical characteristics</b>					
Supply voltage:					
- 100...240 V <sub>AC</sub>	50/60 Hz			-/-	50/60 Hz
- 230/240 V <sub>AC</sub>	-/-	-/-	-/-	50/60 Hz	
- 100...115 V <sub>AC</sub> (optional)	-/-	-/-	-/-	-/-	50/60 Hz
Power consumption	375 W		555 W	2000 W	1000 W
Fuse:					
- 100...240 V <sub>AC</sub>	6.3 A slow			-/-	10.0 A slow
- 230/240 V <sub>AC</sub>	-/-	-/-	-/-	10.0 A slow	6.3 A slow
- 100...115 V <sub>AC</sub> (optional)	-/-	-/-	-/-	-/-	10.0 A slow
Serial interface:					
- Serial interface type	RS 485 optoisolated				
- Communication protocol	MODBUS RTU (JBUS)				
- Serial transfer speed	9600 Baud				
<b>Process variables</b>					
Test specimen holder:					
- Bore	Ø 28 mm	Ø 60 mm	Ø 28 mm	Ø 60 mm	Ø 28 mm
- Depth	150 mm				
- Measurement zone	110...150 mm • Infrared: 110 mm • Surface				
Housing dimensions:					
- Width	210 mm			150 mm	
- Height	380+50 mm			330+70 mm	
- Depth	300 mm			270 mm	
Weight	~10.0 kg	~10.0 kg	~12.5 kg	~7.5 kg	
Sleeves for smaller Ø (in 0.5 mm steps)	1.5...25 mm	1.5...55 mm	1.5...25 mm	1.5...55 mm	1.5...25 mm



## 10.4 Characteristics TP M...S series

Type	TP M165S	TP M255S
<b>Characteristics</b>		
<b>Calibrator</b>		
Temperature range:		
- Micro bath(water)	2...95 °C	T <sub>R</sub> ...95 °C
- Micro bath (silicone oil)	-35...165 °C	T <sub>R</sub> ...255 °C
Accuracy:		
- Micro bath	± 0.1 °C	± 0.2 °
Stability:		
- Micro bath	± 0.05 °C	
Display range	-50...165 °C	0...255 °C
<b>Electrical characteristics</b>		
Supply voltage:		
- 100...240 V <sub>AC</sub>	50/60 Hz	50/60 Hz
- 230/240 V <sub>AC</sub>	-/-	50/60 Hz
- 100...115 V <sub>AC</sub> (optional)	-/-	50/60 Hz
Power consumption	375 W	1000 W
Fuse:		
- 100...240 V <sub>AC</sub>	6.3 A slow	10.0 A slow
- 230/240 V <sub>AC</sub>	-/-	6.3 A slow
- 100...115 V <sub>AC</sub> (optional)	-/-	10.0 A slow
Serial interface:		
- Serial interface type t	RS 485 optoisolated	
- Communication protocol	MODBUS RTU (JBUS)	
- Serial transfer speed	9600 Baud	
<b>Process variables</b>		
Test specimen holder:		
- Bore / Depth	∅ 60 mm / 170 mm	
- Measurement zone	110...150 mm	
Housing dimensions:		
- Width	210 mm	150 mm
- Height	380+50 mm	330+70 mm
- Depth	300 mm	270 mm
Weight	~12.5 kg	~7.5 kg
Sensor basket working depth	150 mm	

## 10.5 Heating and cooling periods

The following measurement conditions apply to heating and cooling times:

- All times are elapsed times without settling time.
- The measurements were carried out at a room temperature of approx. 23 °C
- Without cap, without cover (TP M...S series).
- Regulation is based on the internal reference sensor (except for surface).

Dry block (TP 17... series)

- Reference sensor Pt100, Ø 6 mm, stainless steel casing
- At full depth the reference sensor is located in the middle of the sleeve.

Micro bath (TP M...S series):

- Reference sensor Pt100, Ø 6 mm, stainless steel casing.
- The reference sensor is located 5 mm above the mesh insert in the middle of the tank.

### 10.5.1 TP 17165, TP 17166, TP 17200 (dry block)

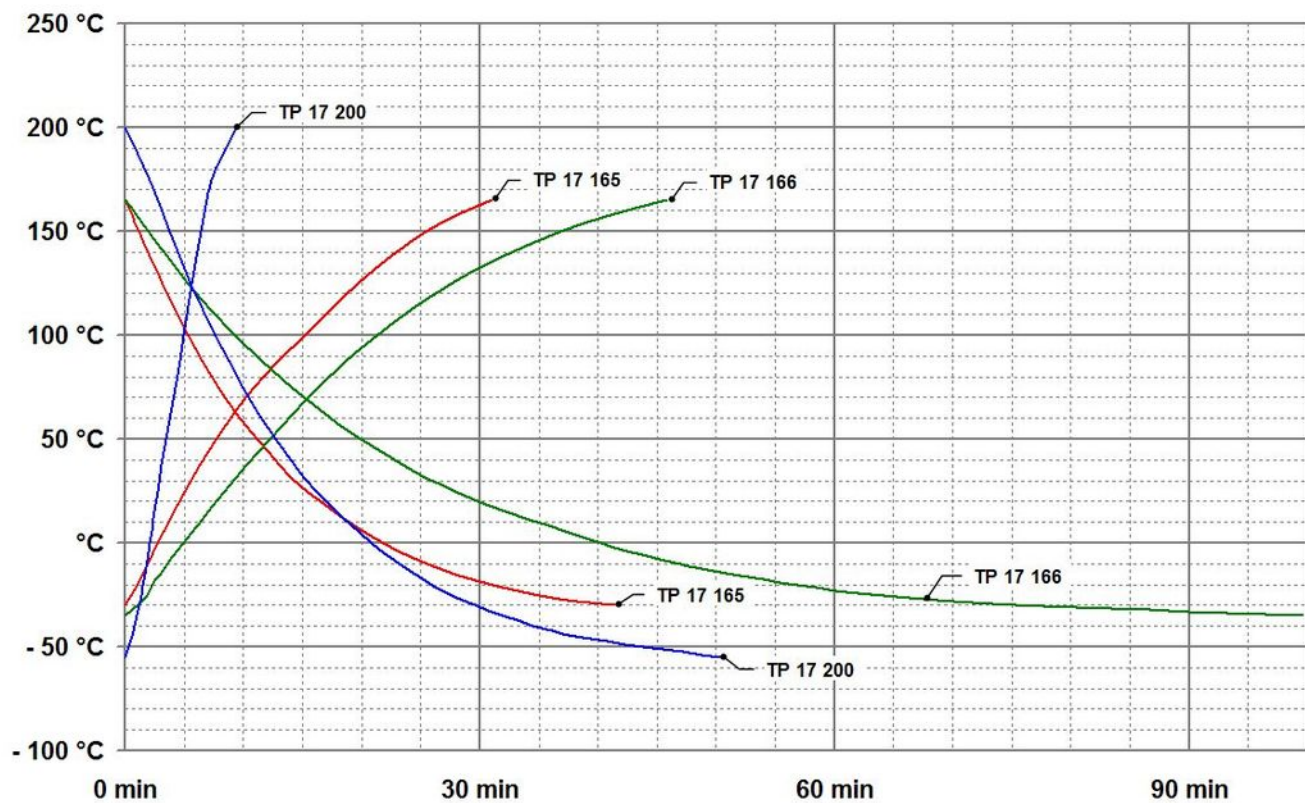

**10.5.2 TP 17450, TP 17650 (dry block)**

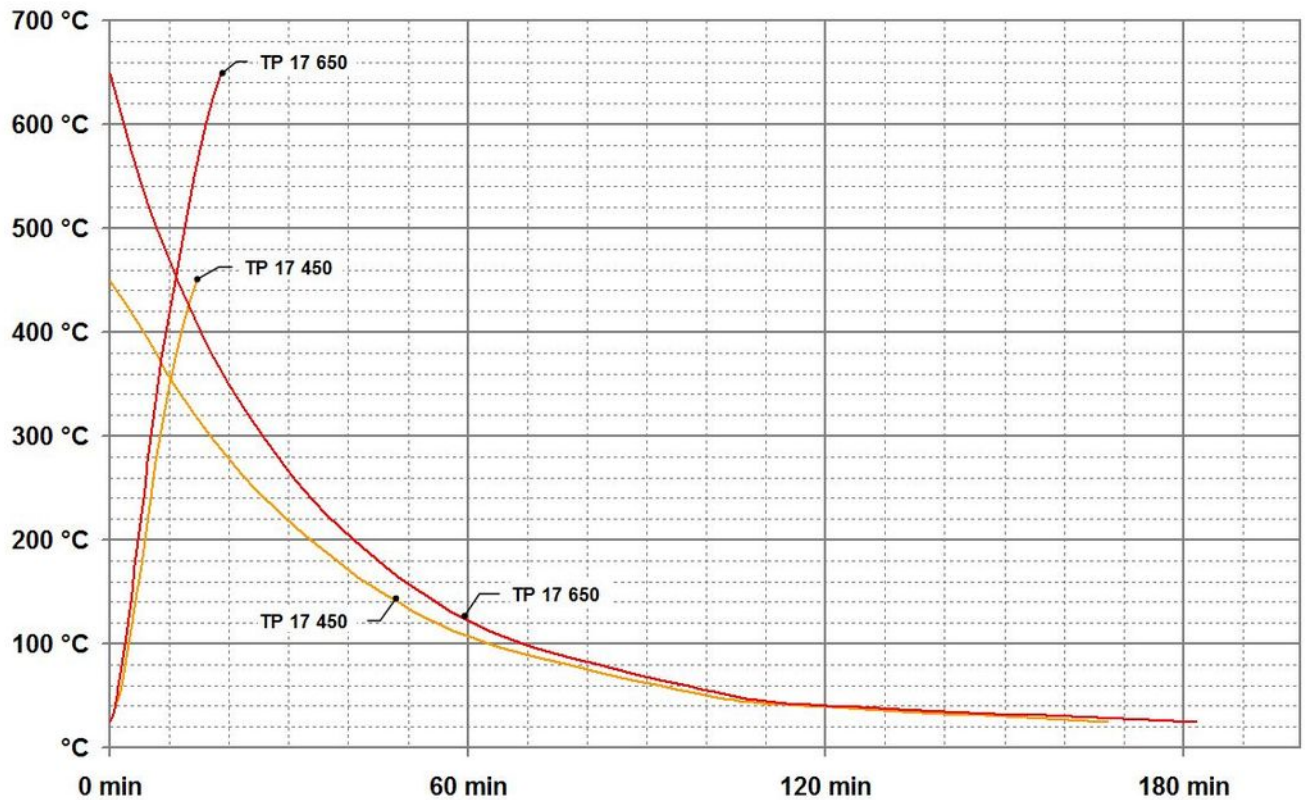

**10.5.3 TP M165S**

**Water and silicone oil**

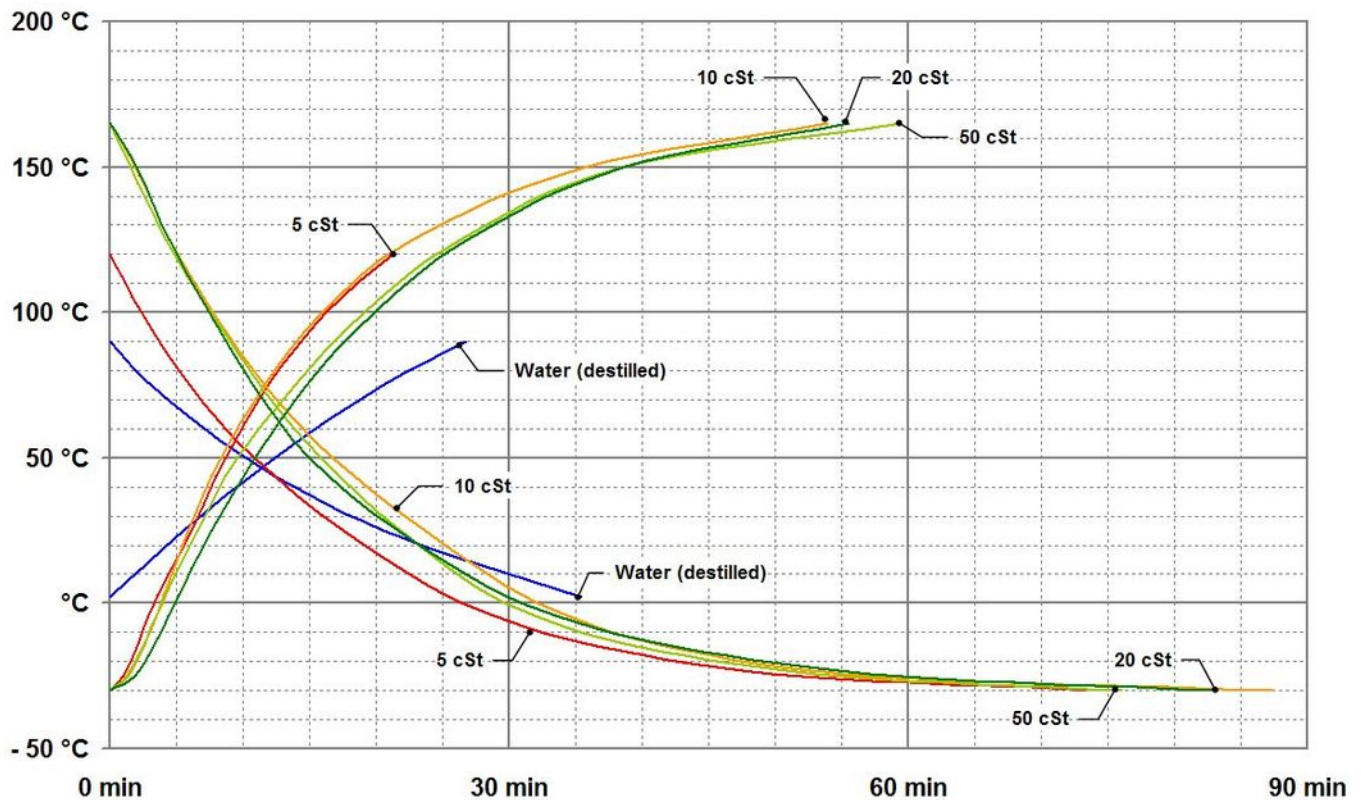

10.5.4 TP M255S

Water and silicone oil

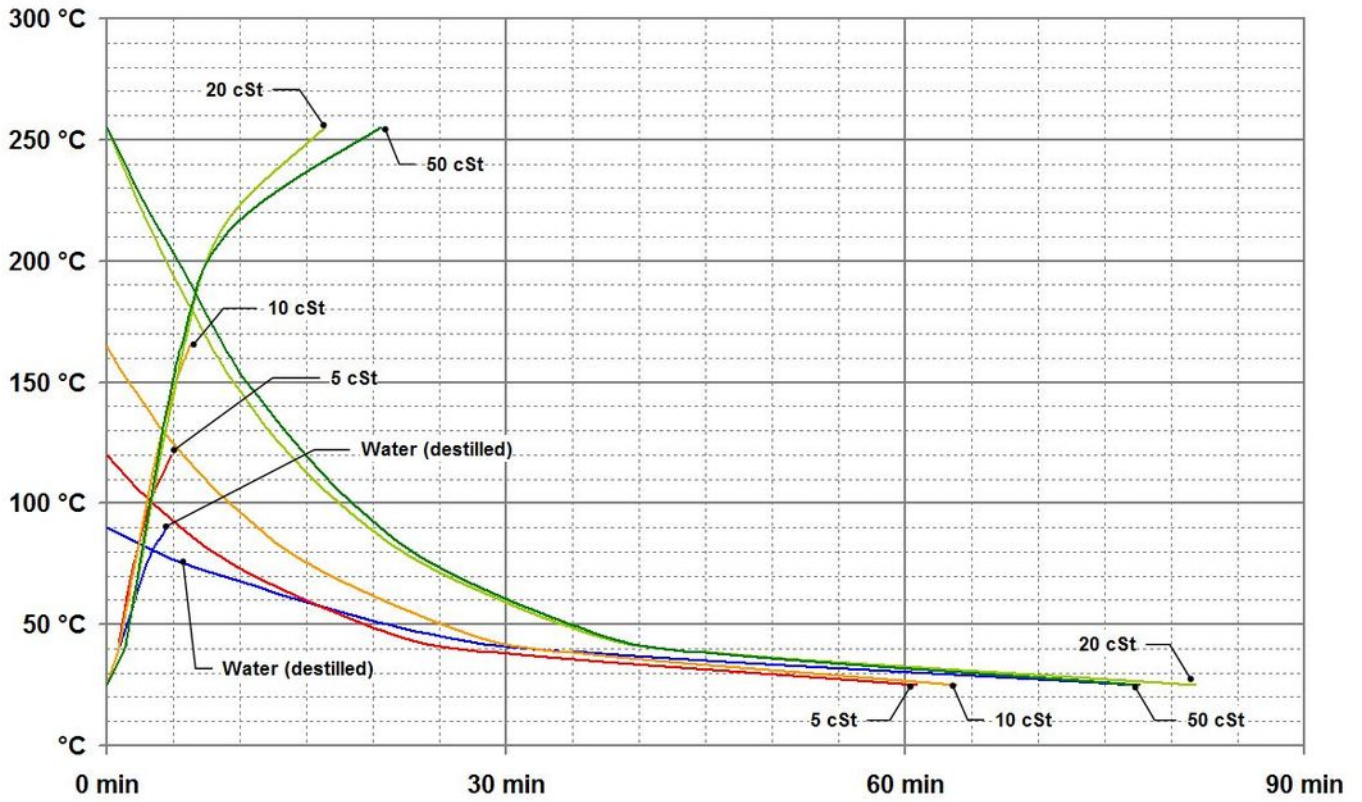



## 11 Guideline DAkkS-DKD-R 5-4 • Appendix B

### Details of the DKD technical committee "Temperature and Humidity" for the operation of temperature block calibrators.

Having a calibrator certificate from a DAkkS calibration laboratory confirms that the temperature block calibrator meets the high demands of the calibrating ability of such a device, which are outlined in the guideline DAkkS-DKD-R 5-4. Nevertheless, the following points should be noted regarding the use of the calibrator:

The calibration of the temperature block calibrator predominantly relates to the temperature of the solid body block. The temperature of the thermometer in the block to be calibrated can differ from this temperature. If a thermometer of the same model, under the same test conditions as were used in the calibration is used, it can be assumed that the measurement difference in the calibration of ideal thermometers are not larger than the measurement inaccuracy which is stated in the calibrator certificate. If it is the case that nothing else is specified on the calibrator certificate, it must be ensured that

- the measuring element is located in the homogeneous temperature zone.
- the inner diameter of the bore hole used in the calibrator (possibly the casing) in the temperature range of  $-80\text{ °C}$  to  $660\text{ °C}$  is a maximum of 0.5 mm bigger than the outer diameter of the calibrated thermometer, and in the temperature range of  $660\text{ °C}$  to  $1300\text{ °C}$  is a maximum of 1.0 mm bigger.
- the immersion depth of the thermometer to be calibrated amounts to at least 15 times the outer diameter of the thermometer to be calibrated.
- the thermometer to be calibrated has an outer diameter of  $d < 6\text{ mm}$ .

Please take particular care if a heat transfer medium was used during the calibration of the temperature block calibrator. If this is the case the calibration is only effective if the calibrator was used with a corresponding heat transfer medium.

With the calibration of thermometers with an outer diameter  $d > 6\text{ mm}$  allow for an additional error of measurement due to heat conduction. In the case that such measurements are required, the additional heat conduction can be determined by the thermometer model and ascertained from your accredited calibration laboratory. A good test of the possible temperature variations caused by heat conduction consists of testing whether the display of the calibrated thermometer changes when it is lifted 20mm. Contributions to measurement inaccuracy that are conditional on the thermometer to be calibrated (e.g. inhomogeneities from thermal elements), are likewise not covered in the measurement inaccuracy of the calibrator.

In the case that the calibrator is used in load conditions that do not comply with the load condition from the calibration, the influence of the load condition can be determined through replacement or addition of other thermometers on site.

The details on the calibration certificate are important for the calibration, not the manufacturers' instructions. Before the calibration, please make sure you agree upon the operation and calibration conditions with your DAkkS calibration laboratory.

If there is nothing else specified on the calibrator certificate, (independent from the manufacturers' instructions) it must be ensured that

- the calibrator is used in a vertical position.
- no additional thermal isolation is in use.
- the environmental temperature is  $(23 \pm 5)\text{ °C}$ .

In order to check the calibration of the temperature block calibrator it is recommended to take regular measurements with a calibrated thermometer. If control measurements with a calibrated thermometer are not taken annually, recalibration of the temperature block calibrator is strongly recommended.

© Deutsche Akkreditierungsstelle GmbH (German Accreditation Body) • E-Mail: [contact@dakks.de](mailto:contact@dakks.de) • Internet: [www.dakks.de](http://www.dakks.de)



Sensors and Measuring Instruments



Flow Measuring Instruments





Test and Calibration Instruments



SIKA Dr. Siebert & Kühn GmbH & Co. KG  
Struthweg 7-9  
D-34260 Kaufungen • Germany

 +49 (0)5605 803-0

 +49 (0)5605 803-54

 [info@sika.net](mailto:info@sika.net)

 [www.sika.net](http://www.sika.net)